

# FUJIFILM

BL00004845-202 **EN**

DIGITAL CAMERA

# X-A10

## Owner's Manual

Thank you for your purchase of this product. This manual describes how to use your FUJIFILM X-A10 digital camera. Be sure that you have read and understood its contents before using the camera.

■ **Product website:**

<http://fujifilm-x.com/x-a10/>

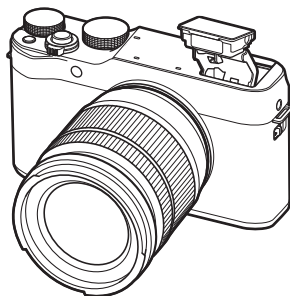

■ **Additional information may be found in online manuals available from:**

<http://fujifilm-dsc.com/manuals/>



Before You Begin

First Steps

Basic Photography  
and Playback

Basic Movie Recording  
and Playback

The Q (Quick Menu) Button  
The Fn (Function) Button

More on Photography  
and Playback

Menus

Connections

Technical Notes

Troubleshooting

Appendix



### IMPORTANT SAFETY INSTRUCTIONS

- **Read Instructions:** All the safety and operating instructions should be read before the appliance is operated.
- **Retain Instructions:** The safety and operating instructions should be retained for future reference.
- **Heed Warnings:** All warnings on the appliance and in the operating instructions should be adhered to.
- **Follow Instructions:** All operating and use instructions should be followed.

#### Installation

**Power Sources:** This video product should be operated only from the type of power source indicated on the marking label. If you are not sure of the type of power supply to your home, consult your appliance dealer or local power company. For video products intended to operate from battery power, or other sources, refer to the operating instructions.

**Grounding or Polarization:** This video product is equipped with a polarized alternating-current line plug (a plug having one blade wider than the other). This plug will fit into the power outlet only one way. This is a safety feature. If you are unable to insert the plug fully into the outlet, try reversing the plug. If the plug should still fail to fit, contact your electrician to replace your obsolete outlet. Do not defeat the safety purpose of the polarized plug.

**Alternate Warnings:** This video product is equipped with a three-wire grounding-type plug, a plug having a third (grounding) pin. This plug will only fit into a grounding-type power outlet. This is a safety feature. If you are unable to insert the plug into the outlet, contact your electrician to replace your obsolete outlet. Do not defeat the safety purpose of the grounding type plug.

**Overloading:** Do not overload wall outlets and extension cords as this can result in a risk of fire or electric shock.

**Ventilation:** Slots and openings in the cabinet are provided for ventilation, to ensure reliable operation of the video product and to protect it from overheating, and these openings must not be blocked or covered. The openings should never be blocked by placing the video product on a bed, sofa, rug, or other similar surface.

This video product should not be placed in a built-in installation such as a bookcase or rack unless proper ventilation is provided or the manufacturer's instructions have been adhered to. This video product should never be placed near or over a radiator or heat register.

**Attachments:** Do not use attachments not recommended by the video product manufacturer as they may cause hazards.

**Water and Moisture:** Do not use this video product near water—for example, near a bath tub, wash bowl, kitchen sink, or laundry tub, in a wet basement, or near a swimming pool, and the like.

**Power-Cord Protection:** Power-supply cords should be routed so that they are not likely to be walked on or pinched by items placed upon or against them, paying particular attention to cords at plugs, convenience receptacles, and the point where they exit from the appliance.

**Accessories:** Do not place this video product on an unstable cart, stand, tripod, bracket, or table. The video product may fall, causing serious injury to a child or adult, and serious damage to the appliance. Use only with a cart, stand, tripod, bracket, or table recommended by the manufacturer, or sold with the video product. Any mounting of the appliance should follow the manufacturer's instructions, and should use a mounting accessory recommended by the manufacturer.

An appliance and cart combination should be moved with care. Quick stops, excessive force, and uneven surfaces may cause the appliance and cart combination to overturn.



#### Antennas

**Outdoor Antenna Grounding:** If an outside antenna or cable system is connected to the video product, be sure the antenna or cable system is grounded so as to provide some protection against voltage surges and built-up static charges. Section 810 of the National Electrical Code, ANSI/NFPA No. 70, provides information with respect to proper grounding of the

mast and supporting structure, grounding of the lead-in wire to an antenna discharge unit, size of grounding conductors, location of antenna discharge unit, connection to grounding electrodes, and requirements for the grounding electrode.

#### EXAMPLE OF ANTENNA GROUNDING AS PER NATIONAL ELECTRICAL CODE

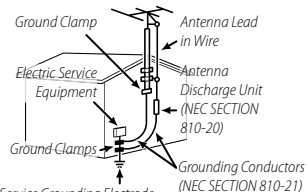

Power Service Grounding Electrode System (NEC ART 250, PART H)

**Power Lines:** An outside antenna system should not be located in the vicinity of overhead power lines or other electric light or power circuits, or where it can fall into such power lines or circuits. When installing an outside antenna system, extreme care should be taken to keep from touching such power lines or circuits as contact with them might be fatal.

#### Use

**Cleaning:** Unplug this video product from the wall outlet before cleaning. Do not use liquid cleaners or aerosol cleaners. Use a damp cloth for cleaning.

**Object and Liquid Entry:** Never push objects of any kind into this video product through openings as they may touch dangerous voltage points or short out parts that could result in a fire or electric shock. Never spill liquid of any kind on the video product.

**Lightning:** For added protection for this video product receiver during a lightning storm, or when it is left unattended and unused for long periods of time, unplug it from the wall outlet and disconnect the antenna or cable system. This will prevent damage to the video product due to lightning and power-line surges.

**Service**

**Service:** Do not attempt to service this video product yourself as opening or removing covers may expose you to dangerous voltage or other hazards. Refer all servicing to qualified service personnel.

**Damage Requiring Service:** Unplug this video product from the wall outlet and refer servicing to qualified service personnel under the following conditions:

- When the power-supply cord or plug is damaged
- If liquid has been spilled, or objects have fallen into the video product.
- If the video product has been exposed to rain or water.
- If the video product has been dropped or the cabinet has been damaged.

If the video product does not operate normally follow the operating instructions. Adjust only those controls that are covered by the operating instructions as an improper adjustment of other controls may result in damage and will often require extensive work by a qualified technician to restore the video product to its normal operation.

When the video product exhibits a distinct change in performance—this indicates a need for service.

**Replacement Parts:** When replacement parts are required, be sure the service technician has used replacement parts specified by the manufacturer or have the same characteristics as the original part. Unauthorized substitutions may result in fire, electric shock or other hazards.



**Safety Check:** Upon completion of any service or repairs to this video product, ask the service technician to perform safety checks to determine that the video product is in proper operating condition.

**Be sure to read these notes before use****Safety Notes**



- Make sure that you use your camera correctly. Read these safety notes and your *Owner's Manual* carefully before use.
- After reading these safety notes, store them in a safe place.

**About the Icons**



The icons shown below are used in this document to indicate the severity of the injury or damage that can result if the information indicated by the icon is ignored and the product is used incorrectly as a result.

	<b>WARNING</b>	This icon indicates that death or serious injury can result if the information is ignored.
	<b>CAUTION</b>	This icon indicates that personal injury or material damage can result if the information is ignored.

The icons shown below are used to indicate the nature of the instructions which are to be observed.

	Triangular icons tell you that this information requires attention ("Important").
	Circular icons with a diagonal bar tell you that the action indicated is prohibited ("Prohibited").
	Filled circles with an exclamation mark indicate an action that must be performed ("Required").

The symbols on the product (including the accessories) represent the following:

	AC
	DC
	Class II equipment (The construction of the product is double-insulated.)

**! WARNING**

Unplug from power socket

**If a problem arises, turn the camera off, remove the battery, and disconnect and unplug the AC power adapter.** Continued use of the camera when it is emitting smoke, is emitting any unusual odor, or is in any other abnormal state can cause a fire or electric shock. Contact your FUJIFILM dealer.



**Do not allow water or foreign objects to enter the camera.** If water or foreign objects get inside the camera, turn the camera off, remove the battery, and disconnect and unplug the AC power adapter. Continued use of the camera can cause a fire or electric shock. Contact your FUJIFILM dealer.



Do not use in the bathroom or shower

**Do not use the camera in the bathroom or shower.** This can cause a fire or electric shock.



Do not disassemble

**Never attempt to change or take apart the camera (never open the case).** Failure to observe this precaution can cause fire or electric shock.



Do not touch internal parts

**Should the case break open as the result of a fall or other accident, do not touch the exposed parts.** Failure to observe this precaution could result in electric shock or in injury from touching the damaged parts. Remove the battery immediately, taking care to avoid injury or electric shock, and take the product to the point of purchase for consultation.











**Do not change, heat or unduly twist or pull the connection cord and do not place heavy objects on the connection cord.** These actions could damage the cord and cause a fire or electric shock. If the cord is damaged, contact your FUJIFILM dealer.





















**Do not place the camera on an unstable surface.** This can cause the camera to fall or tip over and cause injury.



**Never attempt to take pictures while in motion.** Do not use the camera while walking or driving. This can result in you falling down or being involved in a traffic accident.

 <b>WARNING</b>	
	<b>Do not touch any metal parts of the camera during a thunderstorm.</b> This can cause an electric shock due to induced current from the lightning discharge.
	<b>Do not use the battery except as specified.</b> Load the battery as shown by the indicator.
	<b>Do not heat, change or take apart the battery. Do not drop or subject the battery to impacts. Do not store the battery with metallic products.</b> Any of these actions can cause the battery to burst or leak and cause fire or injury as a result.
	<b>Use only batteries or AC power adapters specified for use with this camera. Do not use voltages other than the power supply voltage shown.</b> The use of other power sources can cause a fire.
	<b>If the battery leaks and fluid gets in contact with your eyes, skin or clothing, flush the affected area with clean water and seek medical attention or call an emergency number right away.</b>
	<b>Do not use the charger to charge batteries other than those specified here.</b> The supplied charger is for use only with batteries of the type supplied with the camera. Using the charger to charge conventional batteries or other types of rechargeable batteries can cause the battery to leak, overheat or burst.
	<b>Using a flash too close to a person's eyes may cause visual impairment.</b> Take particular care when photographing infants and young children.
	<b>Do not remain in prolonged contact with hot surfaces.</b> Failure to observe this precaution could result in low-temperature burns, particularly at high ambient temperatures or with users who suffer from poor circulation or reduced sensation, in which case use of a tripod or similar precautions are recommended.

 <b>WARNING</b>	
	<b>Do not leave one part of the body in contact with the product for prolonged periods while the product is on.</b> Failure to observe this precaution could result in low-temperature burns, particularly during prolonged use, at high ambient temperatures, or with users who suffer from poor circulation or reduced sensation, in which case use of a tripod or similar precautions are recommended.
	<b>Do not use in the presence of flammable objects, explosive gases, or dust.</b>
	<b>When carrying the battery, install it in a digital camera or keep it in the hard case. When storing the battery, keep it in the hard case. When discarding, cover the battery terminals with insulation tape.</b> Contact with other metallic objects or batteries could cause the battery to ignite or burst.
	<b>Keep memory cards, hot shoes, and other small parts out of the reach of small children.</b> Children may swallow small parts; keep out of reach of children. Should a child swallow a small part, seek medical attention or call emergency.
	<b>Keep out of the reach of small children.</b> Among the elements that could cause injury are the strap, which could become entangled about a child's neck, causing strangulation, and the flash, which could cause visual impairment.
	<b>Follow the directions of airline and hospital personnel.</b> This product generates radio-frequency emissions that could interfere with navigational or medical equipment.

 <b>CAUTION</b>	
	<b>Do not use this camera in locations affected by oil fumes, steam, humidity or dust.</b> This can cause a fire or electric shock.
	<b>Do not leave this camera in places subject to extremely high temperatures.</b> Do not leave the camera in locations such as a sealed vehicle or in direct sunlight. This can cause a fire.
	<b>Do not place heavy objects on the camera.</b> This can cause the heavy object to tip over or fall and cause injury.
	<b>Do not move the camera while the AC power adapter is still connected.</b> Do not pull on the connection cord to disconnect the AC power adapter. This can damage the power cord or cables and cause a fire or electric shock.
	<b>Do not cover or wrap the camera or the AC power adapter in a cloth or blanket.</b> This can cause heat to build up and distort the casing or cause a fire.
	<b>When you are cleaning the camera or you do not plan to use the camera for an extended period, remove the battery and disconnect and unplug the AC power adapter.</b> Failure to do so can cause a fire or electric shock.
	<b>When charging ends, unplug the charger from the power socket.</b> Leaving the charger plugged into the power socket can cause a fire.
	<b>When a memory card is removed, the card could come out of the slot too quickly. Use your finger to hold it and gently release the card.</b> Injury could result to those struck by the ejected card.
	<b>Request regular internal testing and cleaning for your camera.</b> Build-up of dust in your camera can cause a fire or electric shock. Contact your FUJIFILM dealer to request internal cleaning every two years. Please note that this service is not free of charge.
	<b>Danger of explosion if battery is incorrectly replaced. Replace only with the same or equivalent type.</b>

### The Battery and Power Supply

**Note:** Check the type of battery used in your camera and read the appropriate sections.

The following describes the proper use of batteries and how to prolong their life. Incorrect use can shorten battery life or cause leakage, overheating, fire, or explosion.

#### Li-ion Batteries

Read this section if your camera uses a rechargeable Li-ion battery.

The battery is not charged at shipment. Charge the battery before use. Keep the battery in its case when not in use.

#### ■ Notes on the Battery

The battery gradually loses its charge when not in use. Charge the battery one or two days before use.

Battery life can be extended by turning the camera off when not in use.

Battery capacity decreases at low temperatures; a depleted battery may not function at when cold. Keep a fully charged spare battery in a warm place and exchange as necessary, or keep the battery in your pocket or other warm place and insert it in the camera only when shooting. Do not place the battery in direct contact with hand warmers or other heating devices.

#### ■ Charging the Battery

Charge the battery in the supplied battery charger. Charging times will increase at ambient temperatures below +10°C (+50°F) or above +35°C (+95°F). Do not attempt to charge the battery at temperatures above 40°C (+104°F); at temperatures below 0°C (+32°F), the battery will not charge.

Do not attempt to recharge a fully charged battery. The battery does not however need to be fully discharged before charging.

The battery may be warm to the touch immediately after charging or use. This is normal.

#### ■ Battery Life

At normal temperatures, the battery can be recharged about 300 times. A noticeable decrease in the length of time the battery will hold a charge indicates that it has reached the end of its service life and should be replaced.

#### ■ Storage

Performance may be impaired if the battery is left unused for extended periods when fully charged. Run the battery flat before storing it.

If the camera will not be used for an extended period, remove the battery and store it in a dry place with an ambient temperature of from +15°C to +25°C (+59°F to +77°F). Do not store in locations exposed to extremes of temperature.

#### ■ Cautions: Handling the Battery

- Do not transport or store with metal objects such as necklaces or hairpins.
- Do not expose to flame or heat.
- Do not disassemble or modify.
- Use with designated chargers only.
- Dispose of used batteries promptly.
- Do not drop or subject to strong physical shocks.
- Do not expose to water.
- Keep the terminals clean.
- The battery and camera body may become warm to the touch after extended use. This is normal.

#### ■ Disposal

Dispose of used batteries in accord with local regulations.

#### AC Power Adapters (Available Separately)

Use only FUJIFILM AC power adapters designated for use with this camera. Other adapters could damage the camera.

- The AC power adapter is for indoor use only.
- Be sure the DC plug is securely connected to the camera.
- Turn the camera off before disconnecting the adapter. Disconnect the adapter by the plug, not the cable.
- Do not use with other devices.
- Do not disassemble.
- Do not expose to high heat and humidity.
- Do not subject to strong physical shocks.
- The adapter may hum or become hot to the touch during use. This is normal.
- If the adapter causes radio interference, reorient or relocate the receiving antenna.

### Using the Camera

- Do not aim the camera at extremely bright light sources, such as the sun in a cloudless sky. Failure to observe this precaution could damage the camera image sensor.
- Strong sunlight focused through the viewfinder may damage the panel of electronic viewfinder (EVF). Do not aim the electronic viewfinder at the sun.

#### Take Test Shots

Before taking photographs on important occasions (such as at weddings or before taking the camera on a trip), take a test shot and view the results to ensure that the camera is functioning normally. FUJIFILM Corporation can not accept liability for damages or lost profits incurred as a result of product malfunction.

#### Notes on Copyright

Unless intended solely for personal use, images recorded using your digital camera system cannot be used in ways that infringe copyright laws without the consent of the owner. Note that some restrictions apply to the photographing of stage performances, entertainments, and exhibits, even when intended purely for personal use. Users are also asked to note that the transfer of memory cards containing images or data protected under copyright laws is only permissible within the restrictions imposed by those copyright laws.

#### Handling

To ensure that images are recorded correctly, do not subject the camera to impact or physical shocks while images are being recorded.

### Liquid Crystal

In the event that the display is damaged, care should be taken to avoid contact with liquid crystal. Take the urgent action indicated should any of the following situations arise:

- **If liquid crystal comes in contact with your skin**, clean the area with a cloth and then wash thoroughly with soap and running water.
- **If liquid crystal enters your eyes**, flush the affected eye with clean water for at least 15 minutes and then seek medical assistance.
- **If liquid crystal is swallowed**, rinse your mouth thoroughly with water. Drink large quantities of water and induce vomiting, then seek medical assistance.

Although the display is manufactured using extremely high-precision technology, it may contain pixels that are always lit or that do not light. This is not a malfunction, and images recorded with the product are unaffected.

### Trademark Information

xD-Picture Card and  are trademarks of FUJIFILM Corporation. The typefaces included herein are solely developed by DynaComware Taiwan Inc. Macintosh and Mac OS are trademarks of Apple Inc. in the U.S.A. and other countries. The Windows logo is a trademarks of the Microsoft group of companies. Wi-Fi® and Wi-Fi Protected Setup® are registered trademarks of the Wi-Fi Alliance. The SDHC and SDXC logos are trademarks of SD-3C, LLC. The HDMI logo is a trademark. All other trade names mentioned in this manual are the trademarks or registered trademarks of their respective owners.

### Electrical Interference

This camera may interfere with hospital or aviation equipment. Consult with hospital or airline staff before using the camera in a hospital or on an aircraft.

### Color Television Systems

NTSC (National Television System Committee) is a color television telecasting specification adopted mainly in the U.S.A., Canada, and Japan. PAL (Phase Alternation by Line) is a color television system adopted mainly in European countries and China.

### Exif Print (Exif Version 2.3)

Exif Print is a newly revised digital camera file format in which information stored with photographs is used for optimal color reproduction during printing.

### IMPORTANT NOTICE: Read Before Using the Software

Direct or indirect export, in whole or in part, of licensed software without the permission of the applicable governing bodies is prohibited.

## NOTICES

*To prevent fire or shock hazard, do not expose the unit to rain or moisture.*

*Please read the "Safety Notes" and make sure you understand them before using the camera.*

*Perchlorate Material—special handling may apply. See <http://www.dtsc.ca.gov/hazardouswaste/perchlorate>.*

**For Customers in the U.S.A.****Tested To Comply With FCC Standards****FOR HOME OR OFFICE USE**

Contains IC: 7736B-02100002

Contains FCC ID: W22-02100002

**FCC Statement:** This device complies with Part 15 of the FCC Rules. Operation is subject to the following two conditions: (1) This device may not cause harmful interference, and (2) this device must accept any interference received, including interference that may cause undesired operation.

**CAUTION:** This equipment has been tested and found to comply with the limits for a Class B digital device, pursuant to Part 15 of the FCC Rules. These limits are designed to provide reasonable protection against harmful interference in a residential installation. This equipment generates, uses, and can radiate radio frequency energy and, if not installed and used in accordance with the instructions, may cause harmful interference to radio communications. However, there is no guarantee that interference will not occur in a particular installation. If this equipment does cause harmful interference to radio or television reception, which can be determined by turning the equipment off and on, the user is encouraged to try to correct the interference by one or more of the following measures:

- Reorient or relocate the receiving antenna.
- Increase the separation between the equipment and receiver.
- Connect the equipment into an outlet on a circuit different from that to which the receiver is connected.
- Consult the dealer or an experienced radio/TV technician for help.

**FCC Caution:** Any changes or modifications not expressly approved by the party responsible for compliance could void the user's authority to operate this equipment.

This transmitter must not be co-located or operating in conjunction with any other antenna or transmitter.

**Radiation Exposure Statement:** This device meets the government's requirements for exposure to radio waves. This device is designed and manufactured not to exceed the emission limits for exposure to radio frequency (RF) energy set by the Federal Communications Commission of the U.S. Government.

The exposure standard for wireless device employs a unit of measurement known as the Specific Absorption Rate, or SAR. The SAR limit set by the FCC is 1.6W/kg. \*Tests for SAR are conducted using standard operating positions accepted by the FCC with the device transmitting at its highest certified power level in all tested frequency bands.

**Notes on the Grant:** To comply with Part 15 of the FCC Rules, this product must be used with a Fujifilm-specified ferrite-core A/V cable, USB cable, and DC supply cord.



A lithium ion battery that is recyclable powers the product you have purchased. Please call 1-800-8-BATTERY for information on how to recycle this battery.

**For Customers in Canada****CAN ICES-3 (B)/NMB-3(B)**

**CAUTION:** This Class B digital apparatus complies with Canadian ICES-003.

**Industry Canada statement:** This device complies with RSS-210 of the Industry Canada Rules. Operation is subject to the following two conditions: (1) This device may not cause harmful interference, and (2) this device must accept any interference received, including interference that may cause undesired operation.

This device and its antenna(s) must not be co-located or operating in conjunction with any other antenna or transmitter, except tested built-in radios. The County Code Selection feature is disabled for products marketed in the US/ Canada.

**Radiation Exposure Statement:** The available scientific evidence does not show that any health problems are associated with using low power wireless devices. There is no proof, however, that these low power wireless devices are absolutely safe. Low power Wireless devices emit low levels of radio frequency energy (RF) in the microwave range while being used. Whereas high levels of RF can produce health

effects (by heating tissue), exposure of low-level RF that does not produce heating effects causes no known adverse health effects. Many studies of low-level RF exposures have not found any biological effects. Some studies have suggested that some biological effects might occur, but such findings have not been confirmed by additional research. X-A10 has been tested and found to comply with IC radiation exposure limits set forth for an uncontrolled environment and meets RSS-102 of the IC radio frequency (RF) Exposure rules.

**Disposal of Electrical and Electronic Equipment in Private Households**

**In the European Union, Norway, Iceland and Liechtenstein:** This symbol on the product, or in the manual and in the warranty, and/or on its packaging indicates that this product shall not be treated as household waste. Instead it should be taken to an applicable collection point for the recycling of electrical and electronic equipment.



By ensuring this product is disposed of correctly, you will help prevent potential negative consequences to the environment and human health, which could otherwise be caused by inappropriate waste handling of this product.

This symbol on the batteries or accumulators indicates that those batteries shall not be treated as household waste.



If your equipment contains easy removable batteries or accumulators please dispose these separately according to your local requirements.

The recycling of materials will help to conserve natural resources. For more detailed information about recycling this product, please contact your local city office, your household waste disposal service or the shop where you purchased the product.

**In Countries Outside the European Union, Norway, Iceland and Liechtenstein:** If you wish to discard this product, including the batteries or accumulators, please contact your local authorities and ask for the correct way of disposal.

**In Japan:** This symbol on the batteries indicates that they are to be disposed of separately.



**Be sure to read these notes before use**



**Safety Notes**

Thank you for your purchase of this product. For repair, inspection, and internal testing, contact your FUJIFILM dealer.



- Make sure that you use the lens correctly. Read these safety notes and the camera *Owner's Manual* carefully before use.
- After reading these safety notes, store them in a safe place.

**About the Icons**



The icons shown below are used in this document to indicate the severity of the injury or damage that can result if the information indicated by the icon is ignored and the product is used incorrectly as a result.

	<b>WARNING</b>	This icon indicates that death or serious injury can result if the information is ignored.
	<b>CAUTION</b>	This icon indicates that personal injury or material damage can result if the information is ignored.



The icons shown below are used to indicate the nature of the instructions which are to be observed.

	Triangular icons tell you that this information requires attention ("Important").
	Circular icons with a diagonal bar tell you that the action indicated is prohibited ("Prohibited").
	Filled circles with an exclamation mark indicate an action that must be performed ("Required").







**WARNING**

	<b>Do not immerse in or expose to water.</b> Failure to observe this precaution can cause a fire or electric shock.
	<b>Do not disassemble (do not open the case).</b> Failure to observe this precaution can cause fire, electric shock, or injury due to product malfunction.
	<b>Should the case break open as the result of a fall or other accident, do not touch the exposed parts.</b> Failure to observe this precaution could result in electric shock or in injury from touching the damaged parts. Remove the camera battery immediately, taking care to avoid injury or electric shock, and take the product to the point of purchase for consultation.

**WARNING**

	<b>Do not place on unstable surfaces.</b> The product may fall, causing injury.
	<b>Do not view the sun through the lens or camera viewfinders.</b> Failure to observe this precaution can cause permanent visual impairment.

**CAUTION**

	<b>Do not use or store in locations that are exposed to steam, or smoke or are very humid or extremely dusty.</b> Failure to observe this precaution can cause fire or electric shock.
	<b>Do not leave in direct sunlight or in locations subject to very high temperatures, such as in a closed vehicle on a sunny day.</b> Failure to observe this precaution can cause fire.
	<b>Keep out of the reach of small children.</b> This product could cause injury in the hands of a child.
	<b>Do not handle with wet hands.</b> Failure to observe this precaution can cause electric shock.
	<b>Keep the sun out of the frame when shooting backlit subjects.</b> Sunlight focused into the camera when the sun is in or close to the frame can cause fire or burns.
	<b>When the product is not in use, replace the lens caps and store out of direct sunlight.</b> Sunlight focused by the lens can cause fire or burns.
	<b>Do not carry the camera or lens while they are attached to a tripod.</b> The product can fall or strike other objects, causing injury.



**European Union regulatory notice**

This product complies with the following EU Directives:

- RoHS Directive 2011/65/EU
- RE Directive 2014/53/EU

Hereby, FUJIFILM Corporation declares that the radio equipment type FUJIFILM X-A10 is in compliance with Directive 2014/53/EU.

The full text of the EU declaration of conformity is available at the following internet address:  
[http://www.fujifilm.com/products/digital\\_cameras/x/fujifilm\\_x\\_a10/pdf/index/fujifilm\\_x\\_a10\\_cod.pdf](http://www.fujifilm.com/products/digital_cameras/x/fujifilm_x_a10/pdf/index/fujifilm_x_a10_cod.pdf)

This compliance is indicated by the following conformity marking placed on the product:



This marking is valid for non-Telecom products and EU harmonized Telecom products (e.g. Bluetooth).

**IMPORTANT:** Read the following notices before using the camera's built-in wireless transmitter.

- ① This product, which contains encryption function developed in the United States, is controlled by the United States Export Administration Regulations and may not be exported or re-exported to any country to which the United States embargoes goods.
- **Use only as part of a wireless network.** FUJIFILM does not accept liability for damages resulting from unauthorized use. Do not use in applications requiring a high degree of reliability, for example in medical devices or other systems that may directly or indirectly impact human life. When using the device in computer and other systems that demand a greater degree of reliability than wireless networks, be sure to take all necessary precautions to ensure safety and prevent malfunction.
- **Use only in the country in which the device was purchased.** This device conforms to regulations governing wireless network devices in the country in which it was purchased. Observe all location regulations when using the device. FUJIFILM does not accept liability for problems arising from use in other jurisdictions.
- **Wireless data (images) may be intercepted by third parties.** The security of data transmitted over wireless networks is not guaranteed.
- **Do not use the device in locations subject to magnetic fields, static electricity, or radio interference.** Do not use the transmitter in the vicinity of microwave ovens or in other locations subject to magnetic fields, static electricity, or radio interference that may prevent reception of wireless signals. Mutual interference may occur when the transmitter is used in the vicinity of other wireless devices operating in the 2.4 GHz band.
- **The wireless transmitter operates in the 2.4 GHz band using DSSS and OFDM modulation.**

**Wireless Network Devices: Cautions**

- **This device operates on the same frequency as commercial, educational, and medical devices and wireless transmitters.** It also operates on the same frequency as licensed transmitters and special unlicensed low-voltage transmitters used in RFID tracking systems for assembly lines and in other similar applications.
- **To prevent interference with the above devices, observe the following precautions.** Confirm that the RFID transmitter is not in operation before using this device. Should you observe that the device causes interference in licensed transmitters used for RFID tracking, immediately stop using the affected frequency or move the device to another location. If you notice that this device causes interference in low-voltage RFID tracing systems, contact a FUJIFILM representative.



This sticker indicates that this device operates in the 2.4 GHz band using DSSS and OFDM modulation and may cause interference at distances of up to 40 m.

## About This Manual

Before using the camera, read this manual and the warnings in “For Your Safety” (📖 ii). For information on specific topics, consult the sources below.

### **Table of Contents** ..... 📖 **xiii**

The “Table of Contents” gives an overview of the entire manual. The principal camera operations are listed here.

### **Troubleshooting** ..... 📖 **120**

Having a specific problem with the camera? Find the answer here.

### **Warning Messages and Displays** ..... 📖 **126**

Find out what’s behind that flashing icon or error message in the display.

### **Restrictions on Camera Settings**..... 📖 **137**

See page 137 for restrictions on the options available in each shooting mode.

### **Memory Cards**

Pictures are stored on optional SD, SDHC, and SDXC memory cards (📖 17), referred to in this manual as “memory cards.”

## Product Care

---

**Camera body:** For continued enjoyment of your camera, use a soft, dry cloth to clean the camera body after each use. Do not use alcohol, thinner, or other volatile chemicals, which could discolor or deform the leather on the camera body. Any liquid on the camera should be removed immediately with a soft, dry cloth. Use a blower to remove dust from the monitor, taking care to avoid scratches, and then gently wipe with a soft, dry cloth. Any remaining stains can be removed by wiping gently with a piece of FUJIFILM lens-cleaning paper to which a small amount of lens-cleaning fluid has been applied. To prevent dust entering the camera, replace the body cap when no lens is in place.

**Image sensor:** Dust can be removed from the image sensor using the  **SENSOR CLEANING** option in the setup menu ( 98).

**Interchangeable lenses:** Use a blower to remove dust, then gently wipe with a soft, dry cloth. Any remaining stains can be removed by wiping gently with a piece of FUJIFILM lens-cleaning paper to which a small amount of lens-cleaning fluid has been applied. Replace the front and rear caps when the lens is not use.

# Table of Contents

For Your Safety .....	ii
IMPORTANT SAFETY INSTRUCTIONS .....	ii
Safety Notes .....	iii
NOTICES .....	vi
Safety Notes .....	viii
About This Manual .....	x
Product Care .....	xi
<b>Before You Begin</b>	
Symbols and Conventions .....	1
Supplied Accessories .....	1
Parts of the Camera .....	2
The Selector .....	3
The Main Command and Sub-Command Dials .....	4
The Indicator Lamp .....	5
The LCD Monitor .....	5
Camera Displays .....	6
Shooting .....	6
Playback .....	8
Lenses .....	9
Parts of the Lens .....	9
Removing the Caps .....	9
Attaching the Hood .....	9
Lenses with Aperture Rings .....	10
Lenses with O.I.S. Switches .....	10
Manual Focus Lenses .....	11

## First Steps









Attaching the Strap .....	12
Attaching a Lens .....	13
Inserting the Battery and a Memory Card .....	14
Compatible Memory Cards .....	17
Charging the Battery .....	18
Turning the Camera on and Off .....	21
Basic Setup .....	22
Changing Basic Settings .....	23
The DISP/BACK Button .....	24
Shooting .....	24
Playback .....	24
Customizing the Standard Display .....	25

## Basic Photography and Playback

Taking Photographs .....	27
Viewing Pictures .....	29
Viewing Pictures Full Frame .....	29
Playback Zoom .....	30
Multi-Frame Playback .....	31
Deleting Pictures .....	32

## Basic Movie Recording and Playback

Recording Movies .....	33
Viewing Movies .....	34

<b>The Q (Quick Menu) Button</b>		<b>Focus/Exposure Lock</b> .....	56
<b>Using the Q Button</b> .....	35	<b>White Balance</b> .....	58
The Quick Menu Display .....	35	<b>Burst Mode and Bracketing</b> .....	60
Viewing and Changing Settings .....	35	Continuous Shooting (Burst Mode).....	61
Editing the Quick Menu .....	36	Bracketing.....	62
<b>The Fn (Function) Button</b>		<b>Using the Self-Timer</b> .....	63
<b>Using the Function Button</b> .....	37	<b>Interval Timer Photography</b> .....	65
<b>More on Photography and Playback</b>		<b>Self-Portraits (SELFIE)</b> .....	66
<b>Shooting Mode</b> .....	38	<b>Sensitivity</b> .....	67
 <b>ADVANCED SR AUTO</b> .....	39	AUTO .....	68
<b>Adv. ADVANCED</b> .....	40	<b>Exposure Compensation</b> .....	69
 <b>ADVANCED FILTER</b> .....	41	<b>Metering</b> .....	70
 <b>PANORAMA</b> .....	42	<b>Using the Flash</b> .....	71
 <b>MULTIPLE EXPOSURE</b> .....	44	<b>Film Simulation</b> .....	73
<b>SP SCENE POSITION</b> /  /  /  /  .....	45	<b>Recording Pictures in RAW Format</b> .....	74
Program AE (P) .....	47	Creating JPEG Copies of RAW Pictures .....	75
Shutter-Priority AE (S) .....	48	<b>Using a Mount Adapter</b> .....	76
Aperture-Priority AE (A).....	49	Mount Adapter Settings.....	76
Manual Exposure (M).....	50	Choosing a Focal Length .....	76
Custom Mode (C) .....	51	Distortion Correction .....	76
<b>Focus Mode</b> .....	52	Color Shading Correction.....	77
 <b>MANUAL</b> .....	53	Peripheral Illumination Correction .....	77
The Focus Indicator.....	54	<b>PhotoBook Assist</b> .....	78
Focus-Point Selection.....	55	Creating a PhotoBook.....	78
		Viewing Photobooks .....	79
		Editing and Deleting Photobooks.....	79

**Menus**

<b>Using the Menus: Shooting Mode</b> .....	80
Shooting Menu Options (Photographs) .....	80
SCENE POSITION .....	80
Adv. MODE .....	80
AF/MF SETTING .....	81
ISO .....	83
IMAGE SIZE .....	83
IMAGE QUALITY .....	83
DYNAMIC RANGE .....	84
FILM SIMULATION .....	84
FILM SIMULATION BKT .....	84
SELF-TIMER .....	84
INTERVAL TIMER SHOOTING .....	84
WB WHITE BALANCE .....	84
COLOR .....	84
SHARPNESS .....	84
HIGHLIGHT TONE .....	84
SHADOW TONE .....	85
NR NOISE REDUCTION .....	85
LONG EXPOSURE NR .....	85
CUSTOM SET .....	85
MOUNT ADAPTOR SETTING .....	85
SHOOT WITHOUT LENS .....	85
MF ASSIST .....	85

PHOTOMETRY .....	85
INTERLOCK SPOT AE & FOCUS AREA .....	86
FLASH SET-UP .....	86
MOVIE SET-UP .....	86
IS MODE .....	87
DIGITAL IMAGE STABILIZER .....	88
WIRELESS COMMUNICATION .....	88
SHUTTER TYPE .....	88
<b>Using the Menus: Playback Mode</b> .....	89
Playback Menu Options .....	89
WIRELESS COMMUNICATION .....	89
RAW CONVERSION .....	89
ERASE .....	89
CROP .....	90
RESIZE .....	90
PROTECT .....	91
IMAGE ROTATE .....	91
RED EYE REMOVAL .....	92
SLIDE SHOW .....	92
PHOTOBOOK ASSIST .....	92
PC AUTO SAVE .....	93
PRINT ORDER (DPOF) .....	93
instax PRINTER PRINT .....	93
DISP ASPECT .....	93

<b>The Setup Menu</b> .....	94
Using the Setup Menu .....	94
Setup Menu Options .....	95
🕒 DATE/TIME .....	95
🕒 TIME DIFFERENCE .....	95
🗣️ 言語/LANG. ....	95
🔄 RESET .....	95
🔊 SOUND & FLASH .....	95
🔊 SOUND SET-UP .....	96
🖥️ SCREEN SET-UP .....	96
⚙️ BUTTON SETTING .....	98
👁️ FOCUS RING .....	98
🔌 POWER MANAGEMENT .....	98
🧼 SENSOR CLEANING .....	98
💾 SAVE DATA SET-UP .....	99
🎨 COLOR SPACE .....	100
🔄 CUSTOM RESET .....	100
📶 CONNECTION SETTING .....	101
🗑️ FORMAT .....	102
<b>Factory Defaults</b> .....	103

## Connections

### Wireless Transfer

(FUJIFILM Camera Remote/FUJIFILM PC AutoSave) .....	106
Wireless Connections: Smartphones .....	106
Wireless Connections: Computers .....	106

### Viewing Pictures on a Computer

(MyFinePix Studio/RAW FILE CONVERTER) .....	107
Windows .....	107
Macintosh .....	107
Connecting the Camera .....	108

### Creating a DPOF Print Order

WITH DATE 🗒️/WITHOUT DATE .....	110
RESET ALL .....	111

### instax SHARE Printers

Establishing a Connection .....	112
Printing Pictures .....	113

### Viewing Pictures on TV ..... 114 |

<b>Technical Notes</b>		<b>Appendix</b>	
<b>Optional Accessories</b> .....	115	<b>Memory Card Capacity</b> .....	129
Accessories from FUJIFILM.....	115	<b>Links</b> .....	130
Connecting the Camera to Other Devices.....	117	FUJIFILM X-A10 Product Information .....	130
<b>Caring for the Camera</b> .....	118	Firmware Updates .....	130
Storage and Use .....	118	<b>Specifications</b> .....	131
Traveling.....	118	<b>Restrictions on Camera Settings</b> .....	137
<b>Cleaning the Image Sensor</b> .....	119		
<b>Troubleshooting</b>			
<b>Problems and Solutions</b> .....	120		
<b>Warning Messages and Displays</b> .....	126		



# Before You Begin

## Symbols and Conventions

The following symbols are used in this manual:

- ⓘ This information should be read before use to ensure correct operation.
- ◆ Additional information that may be helpful when using the camera.
- 📖 Other pages in this manual on which related information may be found.

Menus and other text in the displays are shown in **bold**. In the illustrations in this manual, displays may be simplified for explanatory purposes. Illustrations are for explanatory purposes only; drawings may be simplified, while photographs are not necessarily taken with the model of camera described in this manual.

## Supplied Accessories

The following items are included with the camera:



*NP-W126S rechargeable battery*



*AC-5VF AC power adapter*



*Plug adapter  
(Shape of adapter varies  
with region of sale.)*

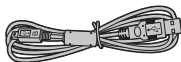

*USB cable*

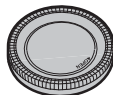

*Body cap*

- Owner's Manual (*this manual*)
- Shoulder strap

- ◆ If you purchased a lens kit, check that a lens is included.

## Parts of the Camera

For more information, refer to the page listed to the right of each item.

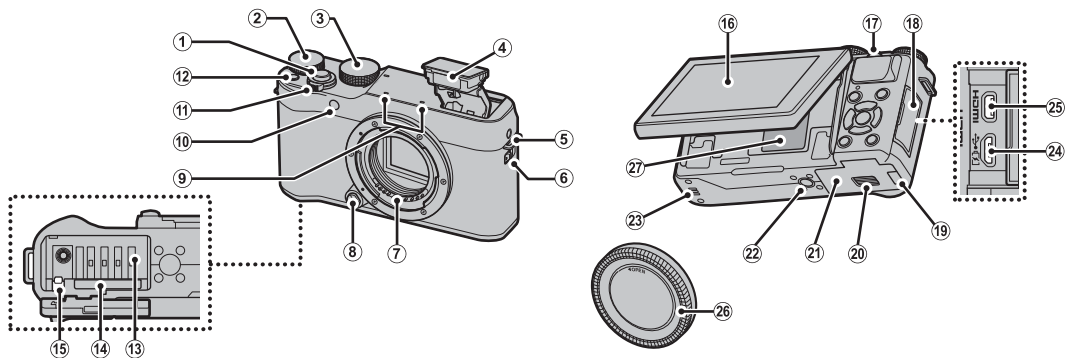

① Shutter button ..... 28	⑪ <b>ON/OFF</b> switch ..... 21	⑳ Tripod mount ..... 34
② Main command dial ..... 4	⑫ <b>Fn</b> (function) button ..... 37	㉑ Speaker ..... 108
③ Mode dial ..... 38	⑬ Battery chamber ..... 14	㉒ Micro USB (Micro-B)/ ..... 108
④ Flash ..... 71	⑭ Memory card slot ..... 15	remote release connector ..... 48, 50
⑤ Strap eyelet ..... 12	⑮ Battery latch ..... 14	㉓ HDMI Micro connector (Type D) ..... 114
⑥  (flash pop-up) switch ..... 71	⑯ LCD monitor ..... 5	㉔ Body cap ..... 13
⑦ Lens signal contacts	⑰ Sub-command dial ..... 4	㉕ Product name plate ..... see below
⑧ Lens release button ..... 13	⑱ Connector cover ..... 108, 114	
⑨ Microphone ..... 33	㉖ Cable channel cover for DC coupler	
⑩ AF-assist illuminator ..... 83	㉗ Battery-chamber cover latch ..... 14	
Self-timer lamp ..... 63	㉘ Battery-chamber cover ..... 14	

### The Product Name Plate

Do not remove the product name plate, which provides the FCC ID, KC mark, serial number, and other important information.

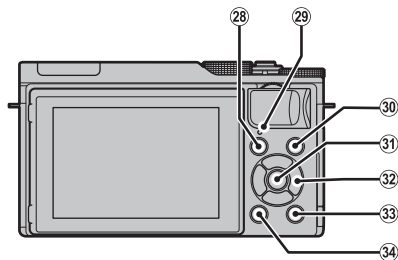

28	[>] (playback) button.....	29
29	Indicator lamp.....	5
30	[MOVIE] (movie recording) button .....	33
31	<b>MENU/OK</b> button .....	see below
	[LOCK] (control lock) button (press and hold)	..... see below
32	Selector.....	see below
33	<b>Q</b> (quick menu) button.....	35
	RAW conversion button (playback mode) .....	75
34	<b>DISP</b> (display)/ <b>BACK</b> button.....	24

### Control Lock





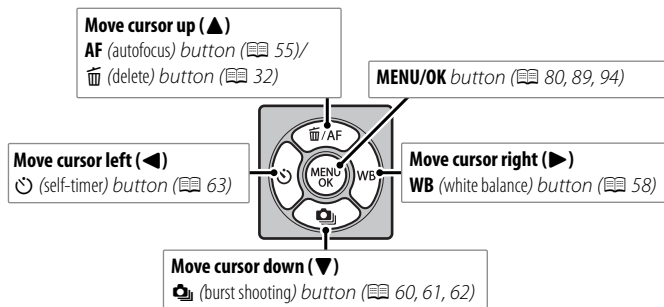



To prevent accidental operation of the selector (**▲▼◀▶**) and **Q** button during shooting, press **MENU/OK** until  is displayed. The controls can be unlocked by pressing **MENU/OK** until  is no longer displayed.

### The Selector



**The Main Command and Sub-Command Dials**

The roles played by the main and sub-command dials vary as shown below.

		Mode						
								
		P (program AE)	S (shutter-priority AE)	A (aperture-priority AE)	M (manual)	Quick menu	Playback	
Main command dial		Exposure compensation (📖 69)			Shutter speed (📖 50)		Choose options (📖 35)	Frame advance (📖 29)
	Sub-command dial	<b>Rotate</b> 	Program shift (📖 47)	Shutter speed (📖 48)	Aperture* (📖 49, 50)			—
<b>Press</b> 		<ul style="list-style-type: none"> <li>• Zoom in on selected focus point (📖 54)</li> <li>• In manual focus mode, press and hold to choose <b>MF ASSIST</b> options (📖 53)</li> <li>• Release shutter when monitor is rotated 180° for self-portraits (📖 66)</li> </ul>						

\* Use aperture ring to adjust aperture.

### The Indicator Lamp

The indicator lamp shows camera status as follows:

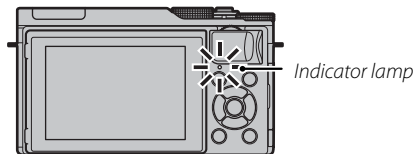

Indicator lamp	Camera status
Glows green	Focus locked.
Blinks green	Blur, focus, or exposure warning. Picture can be taken.
Blinks green and orange	Recording pictures. Additional pictures can be taken.
Glows orange	Recording pictures. No additional pictures can be taken at this time.
Blinks orange	Flash charging; flash will not fire when picture is taken.
Blinks red	Lens or memory error.

◆ Warnings may also appear in the display (126).

### The LCD Monitor

The LCD monitor can be reversed for self-portraits (66) or tilted for ease of viewing when framing pictures.

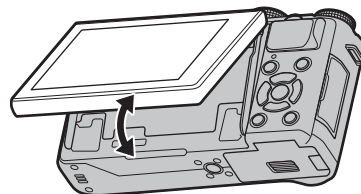

When tilting the monitor, be careful that your fingers and other objects do not get caught between the monitor and the camera body. Do not touch the wires behind the display; failure to observe this precaution could cause camera malfunction.

**Camera Displays**

The following types of indicator may be displayed during shooting and playback. In the description that follows, all available indicators are shown for illustrative purposes; the indicators actually displayed vary with camera settings.

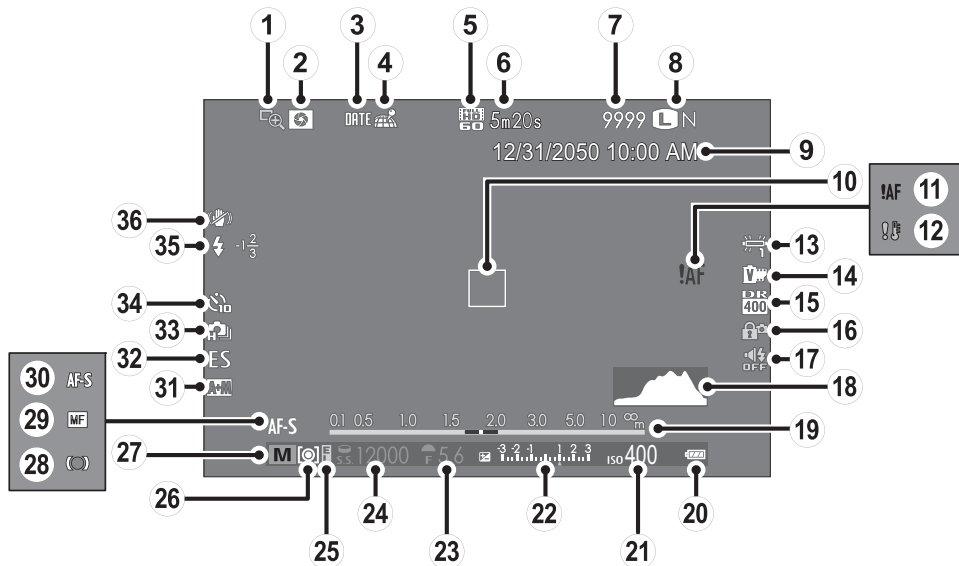
**■ Shooting**

① Focus check.....	54	⑮ Dynamic range .....	84	⑳ Focus indicator.....	54
② Depth-of-field preview .....	49	⑯ Control lock.....	3	㉑ Manual focus indicator .....	53
③ Date stamp .....	100	⑰ Sound and flash indicator .....	95	㉒ Focus mode .....	52
④ Location data download status.....	101	⑱ Histogram.....	26	㉓ AF+MF indicator .....	81
⑤ Movie mode.....	33	⑲ Distance indicator .....	53	㉔ Shutter type.....	88
⑥ Time remaining .....	33	⑳ Battery level .....	21	㉕ Continuous mode .....	60
⑦ Number of available frames * .....	129	㉑ Sensitivity.....	67	㉖ Self-timer indicator .....	63
⑧ Image quality and size.....	83	㉒ Exposure compensation/exposure indicator .....	50, 69	㉗ Flash mode .....	71
⑨ Date and time .....	22	㉓ Aperture .....	47, 49, 50	Flash compensation .....	86
⑩ Focus frame .....	28, 56	㉔ Shutter speed .....	47, 48, 50	㉘ IS mode .....	87
⑪ Focus warning .....	122, 126	㉕ AE lock indicator .....	56		
⑫ Temperature warning .....	128	㉖ Metering.....	70		
⑬ White balance.....	58	㉗ Shooting mode.....	38		
⑭ Film simulation.....	73				

\* Shows "9999" if there is space for over 9999 frames.

### Control Lock



Pressing a locked control (🔒 3) displays a 🔒 icon.

## ■ Playback

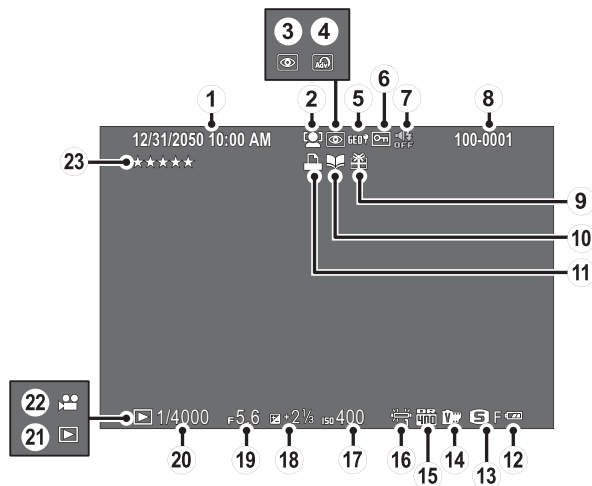

① Date and time.....	22	⑨ Gift image.....	29	⑰ Sensitivity.....	67
② Intelligent face detection indicator.....	82	⑩ Photobook assist indicator.....	78	⑱ Exposure compensation.....	69
③ Red-eye removal indicator.....	92	⑪ DPOF print indicator.....	110	⑲ Aperture.....	47, 49, 50
④ Advanced filter.....	41	⑫ Battery level.....	21	⑳ Shutter speed.....	47, 48, 50
⑤ Location data.....	101	⑬ Image quality and size.....	83	㉑ Playback mode indicator.....	29
⑥ Protected image.....	91	⑭ Film simulation.....	73	㉒ Movie icon.....	34
⑦ Sound and flash indicator.....	95	⑮ Dynamic range.....	84	㉓ Rating.....	29
⑧ Frame number.....	99	⑯ White balance.....	58		



## Lenses

The camera can be used with lenses for the FUJIFILM X-mount and the other accessories listed from page 115.

### Parts of the Lens

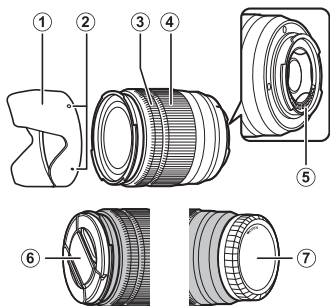

- ① Lens hood
- ② Mounting marks
- ③ Focus ring
- ④ Zoom ring
- ⑤ Lens signal contacts
- ⑥ Front lens cap
- ⑦ Rear lens cap

### Removing the Caps

Remove the caps as shown.

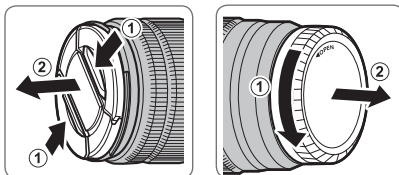

### Attaching the Hood

When attached, lens hoods reduce glare and protect the front lens element.

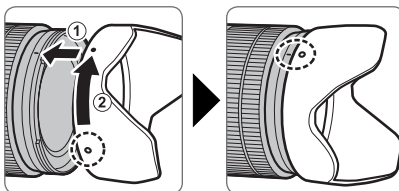

**Lenses with Aperture Rings**

At settings other than **A**, you can adjust aperture by rotating the lens aperture ring (exposure modes **A** and **M**).

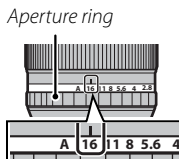
**The Aperture Mode Switch**

If the lens has an aperture mode switch, aperture can be adjusted manually by sliding the switch to  and rotating the aperture ring.

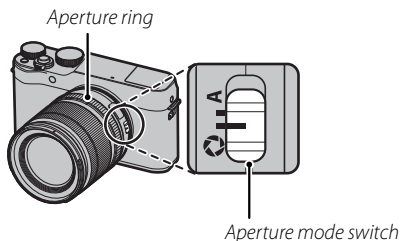

- ① When the aperture ring is set to **A**, rotate the sub-command dial to adjust aperture.
- 🔑 For information on the roles of the main and sub-command dials, see page 4.

**Lenses with O.I.S. Switches**

If the lens supports optical image stabilization (O.I.S.), the image stabilization mode can be chosen in the camera menus. To activate image stabilization, slide the O.I.S. switch to **ON**.

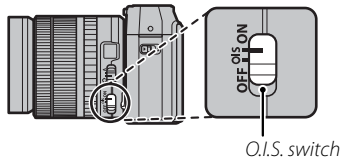

### **Manual Focus Lenses**

Slide the focus ring to the front for autofocus.

For manual focus (📖 53), slide the focus ring to the back and rotate it while checking the results in the camera display. The focus distance and depth-of-field indicators can be used to assist manual focus. Note that manual focus may not be available in all shooting modes.



### **The Depth-of-Field Indicator**

The depth-of-field indicator shows the approximate depth of field (the distance in front of and behind the focus point that appears to be in focus).



- ⓘ The camera does not display the focus distance when the lens is in manual focus mode.

## First Steps

### Attaching the Strap

Attach the strap to the two strap eyelets as shown below.

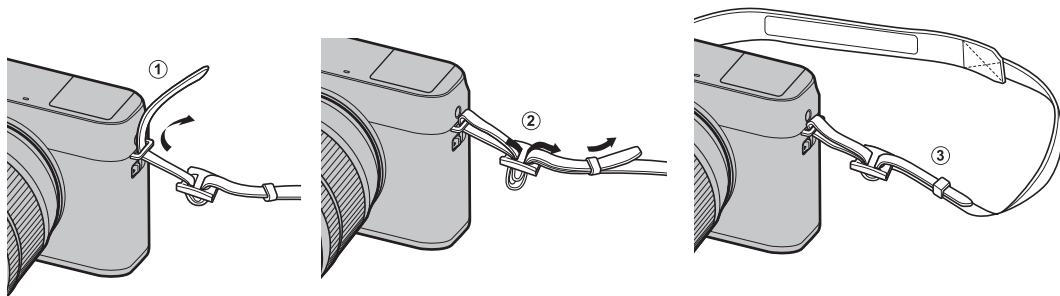

① To avoid dropping the camera, be sure the strap is correctly secured.

## Attaching a Lens

Lenses attach as described below.

① Care is required to prevent dust entering the camera while attaching and removing lenses.

### 1 Remove the body and rear caps.

Remove the body cap from the camera and the rear cap from the lens.

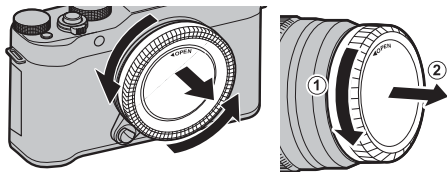

① Do not touch the camera's internal parts.

### 2 Attach the lens.

Place the lens on mount, keeping the marks on the lens and camera aligned, and then rotate the lens until it clicks into place.

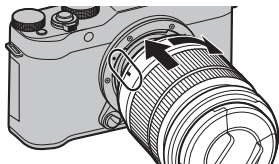

① Do not press the lens release button while attaching the lens.

### ● Removing Lenses

To remove the lens, turn the camera off, then press the lens release button and rotate the lens as shown.

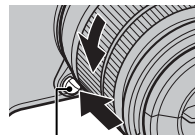

① To prevent dust accumulating on the lens or inside the camera, replace the lens caps and camera body cap when the lens is not attached.

### ● Lenses and Other Optional Accessories

The camera can be used with lenses for the FUJIFILM X-mount and the other accessories listed from page 115.

## Inserting the Battery and a Memory Card

The camera has no internal memory; instead, pictures are stored on optional SD, SDHC, and SDXC memory cards (sold separately). Insert the battery and memory card as described below.

### 1 Open the battery-chamber cover.

Slide the battery-chamber latch as shown and open the battery-chamber cover.

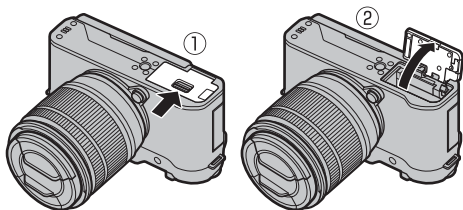

- ① Do not open the battery-chamber cover when the camera is on. Failure to observe this precaution could damage image files or memory cards.
- ① Do not use excessive force when handling the battery-chamber cover.

### 2 Insert the battery.

Using the battery to keep the battery latch pressed to one side, insert the battery contacts first in the direction shown by the arrow. Confirm that the battery is securely latched.

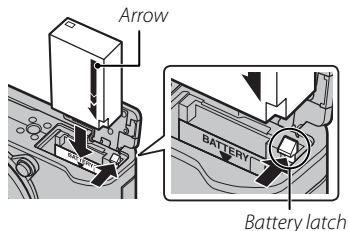

- ① Insert the battery in the correct orientation. **Do not use force or attempt to insert the battery upside down or backwards.** The battery will slide in easily in the correct orientation.

### 3 Insert the memory card.

Holding the memory card in the orientation shown, slide it in until it clicks into place at the back of the slot.

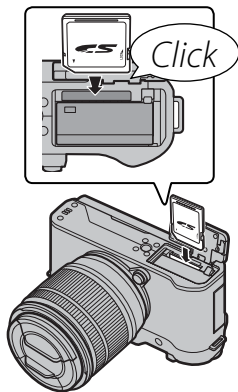

① Be sure card is in the correct orientation; do not insert at an angle or use force.

① SD/SDHC/SDXC memory cards can be locked, making it impossible to format the card or to record or delete images.

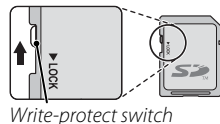

Before inserting a memory card, slide the write-protect switch to the unlocked position.

### 4 Close the battery-chamber cover.

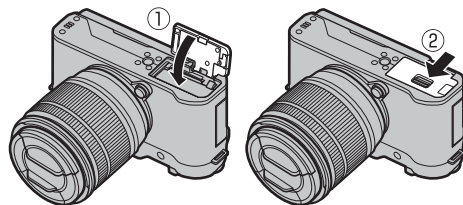

### ● Removing the Battery and Memory Card

Before removing the battery or memory card, **turn the camera off** and open the battery-chamber cover.

To remove the battery, press the battery latch to the side, and slide the battery out of the camera as shown.

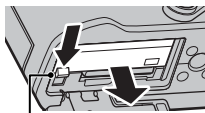

Battery latch

ⓘ The battery may become hot when used in high-temperature environments. Observe caution when removing the battery.

To remove the memory card, press it in and release it slowly. The card can then be removed by hand. When a memory card is removed, the card could be ejected too quickly. Use your finger to hold it and gently release the card.

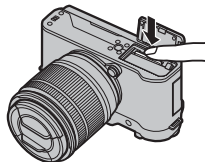

ⓘ Press the center of the card when ejecting it.

### ⓘ Batteries

- Remove dirt from the battery terminals with a clean, dry cloth. Failure to observe this precaution could prevent the battery from charging.
- Do not affix stickers or other objects to the battery. Failure to observe this precaution could make it impossible to remove the battery from the camera.
- Do not short the battery terminals. The battery could overheat.
- Read the cautions in “The Battery and Power Supply” (📖 v).
- Use only battery chargers designated for use with the battery. Failure to observe this precaution could result in product malfunction.
- Do not remove the labels from the battery or attempt to split or peel the outer casing.
- The battery gradually loses its charge when not in use. Charge the battery one or two days before use.



## ■ Compatible Memory Cards

FUJIFILM and SanDisk SD, SDHC, and SDXC memory cards have been approved for use in the camera. A complete list of approved memory cards is available at [http://www.fujifilm.com/support/digital\\_cameras/compatibility/](http://www.fujifilm.com/support/digital_cameras/compatibility/). Operation is not guaranteed with other cards. The camera can not be used with *xD-Picture Cards* or **MultiMediaCard** (MMC) devices.

### ⓘ Memory Cards

- ***Do not turn the camera off or remove the memory card while the memory card is being formatted or data are being recorded to or deleted from the card.*** Failure to observe this precaution could damage the card.
- Format memory cards before first use, and be sure to reformat all memory cards after using them in a computer or other device. For more information on formatting memory cards, see page 102.
- Memory cards are small and can be swallowed; keep out of reach of children. If a child swallows a memory card, seek medical assistance immediately.
- miniSD or microSD adapters that are larger or smaller than the standard dimensions of an SD/SDHC/SDXC card may not eject normally; if the card does not eject, take the camera to an authorized service representative. Do not forcibly remove the card.
- Do not affix labels to memory cards. Peeling labels can cause camera malfunction.
- Movie recording may be interrupted with some types of SD/SDHC/SDXC memory card. Use a **CLASS10** card or better for movies and burst photography.
- Formatting a memory card in the camera creates a folder in which pictures are stored. Do not rename or delete this folder or use a computer or other device to edit, delete, or rename image files. Always use the camera to delete pictures; before editing or renaming files, copy them to a computer and edit or rename the copies, not the originals. Renaming the files on the camera can cause problems during playback.

## Charging the Battery

The battery is not charged at shipment. Turn the camera off and charge the battery before use. The camera charges the battery internally.

- The camera uses an NP-W126S rechargeable battery.
- See the specifications (📖 134) for charging times.

### 1 Attach the plug adapter to the AC power adapter.

Attach the plug adapter as shown, making sure that it is fully inserted and clicks into place on the AC power adapter terminals.

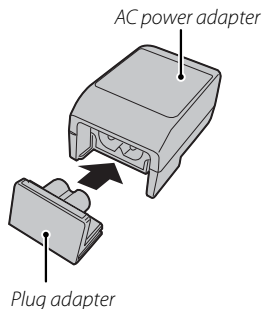

- ① The plug adapter is exclusively for use with the supplied AC power adapter. Do not use it with other devices.

### 2 Charge the battery.

Connect the camera to the supplied AC power adapter using the supplied USB cable. Then plug the AC power adapter into an indoor power outlet.

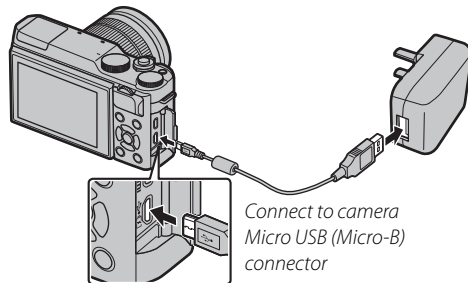

- ① Be sure the connectors are in the correct orientation and then insert them fully.

 **Charge Status**

The indicator lamp shows battery charge status as follows:

Indicator lamp	Battery status
On	Battery charging.
Off	Charging complete.
Blinks	Battery fault.

- ⓘ The battery will not charge while the camera is on.
- ⓘ Remove dirt from the battery terminals with a clean, dry cloth. Failure to observe this precaution could prevent the battery from charging.
- ⓘ Do not affix stickers or other objects to the battery. Failure to observe this precaution could make it impossible to remove the battery from the camera.
- ⓘ Do not short the battery terminals. The battery could overheat.
- ⓘ Read the cautions in “The Battery and Power Supply”.
- ⓘ Use only battery chargers designated for use with the battery. Failure to observe this precaution could result in product malfunction.
- ⓘ Do not remove the labels from the battery or attempt to split or peel the outer casing.
- ⓘ The battery gradually loses its charge when not in use. Charge the battery one or two days before use. If the battery fails to hold a charge, it has reached the end of its charging life and must be replaced.
- ⓘ Charging times may increase at very low or very high temperatures.

### Charging via a Computer

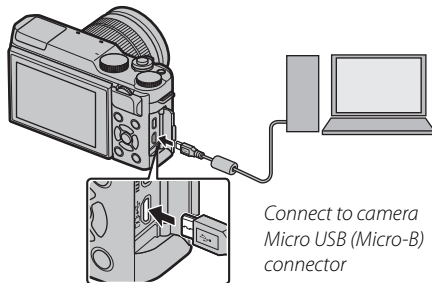

The battery can be charged by connecting the camera to a computer. Connect the supplied USB cable as shown, making sure the connectors are fully inserted.



- ❶ The battery will not charge while the camera is on.
- ❶ Connect the camera directly to the computer; do not use a USB hub or keyboard.
- ❶ Charging stops if the computer enters sleep mode; to resume charging, activate the computer and disconnect and reconnect the USB cable.
- ❶ Charging may not be supported depending on the model of computer, computer settings, and the computer's current state.

## Turning the Camera on and Off



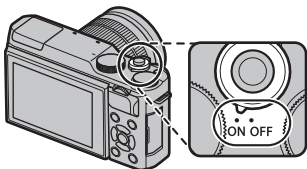

Rotate the **ON/OFF** switch to **ON** to turn the camera on. Select **OFF** to turn the camera off.

- ◆ Press the  button to start playback. Press the shutter button halfway to return to shooting mode.
  - ◆ The camera will turn off automatically if no operations are performed for the length of time selected for  **POWER MANAGEMENT** > **AUTO POWER OFF** (📖 98). To reactivate the camera after it has turned off automatically, press the shutter button halfway or turn the **ON/OFF** switch to **OFF** and then back to **ON**.
  - ◆ For information on startup options, see page 98.
- ⓘ Fingerprints and other marks on the lens can affect pictures and the view through the lens in the camera display. Keep the lens clean.



### Battery Level

After turning the camera on, check the battery level in the display.

Indicator	Description
 (white)	Battery partially discharged.
 (white)	Battery about two-thirds charged.
 (white)	Battery about one-third charged. Charge as soon as possible.
 (red)	Low battery. Charge battery.
 (blinks red)	Battery exhausted. Turn camera off and recharge battery.

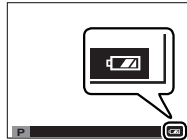

## Basic Setup

A language-selection dialog is displayed the first time the camera is turned on.

### 1 Choose a language.

Highlight a language and press **MENU/OK**.

- ◆ Press **DISP/BACK** to skip the current step. Any steps you skip will be displayed the next time the camera is turned on.



### 2 Set the date and time.

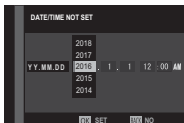

Press the selector left or right to highlight the year, month, day, hour, or minute and press up or down to change. To change the order in which the year, month, and day are displayed, highlight the date format and press the selector up or down. Press **MENU/OK** to exit to shooting mode when settings are complete.





- ◆ If the battery is removed for an extended period, the camera clock will be reset and the language-selection dialog will be displayed when the camera is turned on.

## **Changing Basic Settings**

To change the language or reset the clock:

### **1 Display the desired option.**

Display the setup menu and select  言語/LANG. to change the language or  DATE/TIME to reset the clock (📖 94).

### **2 Adjust settings.**

To choose a language, highlight the desired option and press **MENU/OK**. To set the clock, press the selector left or right to highlight the year, month, day, hour, or minute and press up or down to change, then press **MENU/OK** once the clock has been set to your satisfaction.

## The DISP/BACK Button

Press **DISP/BACK** to cycle through display modes as follows:

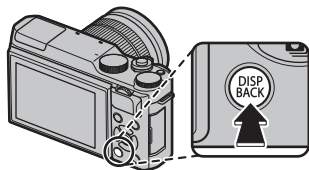

### Shooting

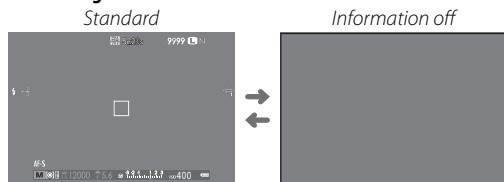

### Playback

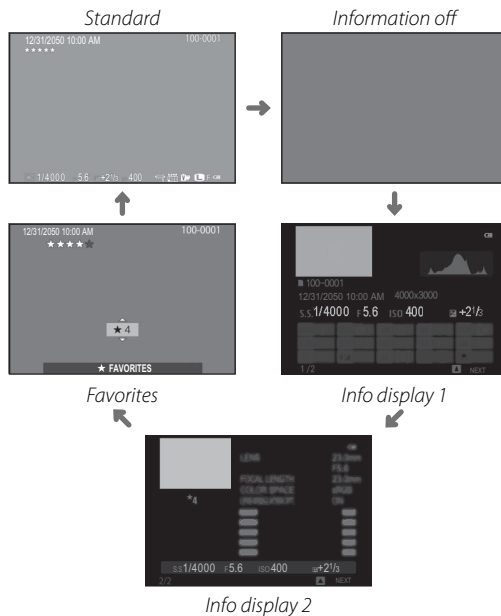



## ■ Customizing the Standard Display

To choose the items shown in the standard display:

### 1 Display standard indicators.

Press the **DISP/BACK** button to display standard indicators.

### 2 Select **DISP. CUSTOM SETTING**.

Select  **SCREEN SET-UP > DISP. CUSTOM SETTING** in the setup menu.

### 3 Choose items.

Highlight items and press **MENU/OK** to select or deselect.

- FRAMING GUIDELINE
- FOCUS FRAME
- AF DISTANCE INDICATOR
- MF DISTANCE INDICATOR
- HISTOGRAM
- SHOOTING MODE
- APERTURE/S-SPEED/ISO
- INFORMATION BACKGROUND
- EXPOSURE COMPENSATION
- FOCUS MODE
- PHOTOMETRY
- SHUTTER TYPE
- FLASH
- CONTINUOUS MODE
- DUAL IS MODE
- WHITE BALANCE
- FILM SIMULATION
- DYNAMIC RANGE
- FRAMES REMAINING
- IMAGE SIZE/QUALITY
- MOVIE MODE & REC. TIME
- BATTERY LEVEL

### 4 Save changes.

Press **DISP/BACK** to save changes.

### 5 Exit the menus.

Press **DISP/BACK** as needed to exit the menus and return to the shooting display.

◆ See page 6 for the locations of these items in the displays.

## Histograms

Histograms show the distribution of tones in the image. Brightness is shown by the horizontal axis, the number of pixels by the vertical axis.

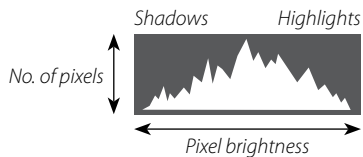

**Optimal exposure:** Pixels are distributed in an even curve throughout the tone range.



**Overexposed:** Pixels are clustered on the right side of the graph.



**Underexposed:** Pixels are clustered on the left side of the graph.



# Basic Photography and Playback

## Taking Photographs

This section explains basic photography.

### 1 Select **SR+** mode.

Rotate the mode dial to **SR+** (ADVANCED SR AUTO). The following information will be displayed in the LCD monitor.

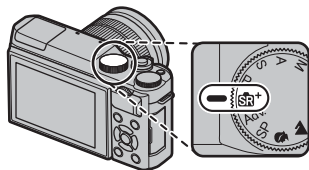

### Scene Icon

The camera automatically selects the appropriate scene.

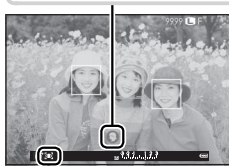

### The Icon

In **SR+** mode, the camera continuously adjusts focus and searches for eyes, increasing the drain on the battery; in addition, the sound of the camera focusing may be audible.  is displayed in the LCD monitor.

- ◆ The **Q** button can be used to view and adjust camera settings (📖 35).

## 2 Ready the camera.

Hold the camera steady with both hands and brace your elbows against your sides. Shaking or unsteady hands can blur your shots.



To prevent pictures that are out of focus or too dark (underexposed), keep your fingers and other objects away from the lens, flash, and AF-assist illuminator.



## 3 Frame the picture.

Use the zoom ring to frame the picture in the display.

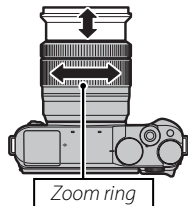

## 4 Focus.

Frame the picture with your subject in the center of the display and press the shutter button halfway to focus.



❖ If the subject is poorly lit, the AF-assist illuminator may light (☞ 83).

**If the camera is able to focus**, it will beep twice and focus area will glow green. Focus and exposure will lock while the shutter button is pressed halfway.

**If the camera is unable to focus**, the focus frame will turn red, and **!AF** will be displayed.

## 5 Shoot.

Smoothly press the shutter button the rest of the way down to take the picture.



## Viewing Pictures

### Viewing Pictures Full Frame

Pictures can be viewed in the LCD monitor. When taking important pictures, take a test shot and check the results.

To view pictures full frame, press .

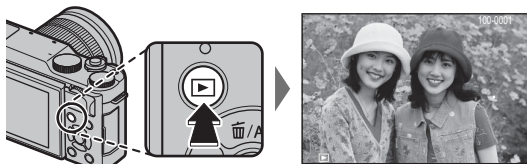

Additional pictures can be viewed by pressing the selector left or right or rotating the main command dial. Press the selector or rotate the dial right to view pictures in the order recorded, left to view pictures in reverse order. Keep the selector pressed to scroll rapidly to the desired frame.



- ◆ Pictures taken using other cameras are marked with a  ("gift image") icon to warn that they may not display correctly and that playback zoom may not be available.

### Favorites: Rating Pictures

To rate the current picture, press **DISP/BACK** and press the selector up and down to select from zero to five stars.

### Zooming in on the Focus Point

Press the center of the sub-command dial to zoom in on the focus point. Press the center of the sub-command dial again to return to full-frame playback.

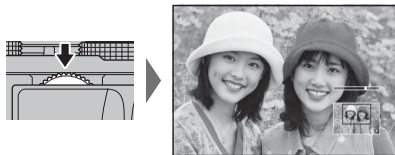

**Playback Zoom**

Rotate the sub-command dial to zoom in or out on pictures in full-frame playback.



- ◆ To display multiple images, rotate the sub-command dial left when a picture is displayed full frame.



*Navigation window shows portion of image currently displayed*

- ◆ The maximum zoom ratio varies with image size (83). Playback zoom is not available with cropped or resized copies saved at a size of 640.

**Multi-Frame Playback**

To view multiple images, rotate the sub-command dial left when a picture is displayed full frame. Use the sub-command dial to choose the number of images displayed.

*Rotate the sub-command dial left to view more images.*

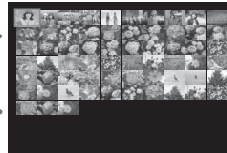

*Rotate the sub-command dial right to view fewer images.*

Use the selector to highlight images and press **MENU/OK** to view the highlighted image full frame. In the nine- and hundred-frame displays, press the selector up or down to view more pictures.

## Deleting Pictures

To delete individual pictures, multiple selected pictures, or all pictures, press the selector up (▲), and choose from the options below. *Note that deleted pictures can not be recovered. Copy important pictures to a computer or other storage device before proceeding.*

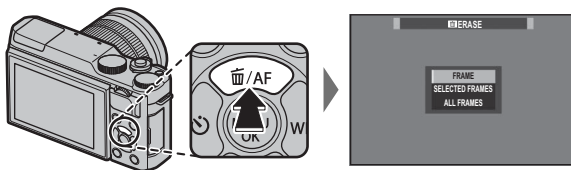

Option	Description
<b>FRAME</b>	Press the selector left or right to scroll through pictures and press <b>MENU/OK</b> to delete the current picture (a confirmation dialog is not displayed). Repeat to delete additional pictures.
<b>SELECTED FRAMES</b>	Highlight pictures and press <b>MENU/OK</b> to select or deselect (pictures in photobooks or print orders are shown by ■). When the operation is complete, press <b>DISP/BACK</b> to display a confirmation dialog, then highlight <b>OK</b> and press <b>MENU/OK</b> to delete the selected pictures.
<b>ALL FRAMES</b>	A confirmation dialog will be displayed; highlight <b>OK</b> and press <b>MENU/OK</b> to delete all unprotected pictures. Pressing <b>DISP/BACK</b> cancels deletion; note that any pictures deleted before the button was pressed can not be recovered.

- ❖ Protected pictures can not be deleted. Remove protection from any pictures you wish to delete (📖 91).
- ❖ Pictures can also be deleted by **ERASE** from playback menu (📖 89).
- ❖ If a message appears stating that the selected images are part of a DPOF print order (📖 110), press **MENU/OK** to delete the pictures.



# Basic Movie Recording and Playback

## Recording Movies



The camera can be used to record short high-definition movies. Sound is recorded in stereo via the built-in microphone; do not cover the microphone during recording.

- 1 Press  to start recording.

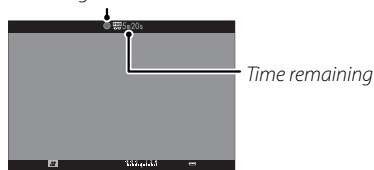
Recording indicator



- 2 To end recording, press the  button again. Recording ends automatically when the movie reaches maximum length or memory is full.

- ◆ Zoom can be adjusted while recording is in progress.
- ◆ Sensitivity and frame size and rate can be selected using the  **MOVIE SET-UP** option (86).
- ◆ Use the  **MOVIE SET-UP** > **FOCUS MODE** option to choose how the camera focuses during movie recording.
- ◆ During recording, exposure compensation can be adjusted by up to  $\pm 2$  EV.
- ◆ The indicator lamp lights while movies are being recorded.

- ◆ The area recorded when **ON** is selected for  **DIGITAL IMAGE STABILIZER** is smaller than that shown in the monitor (88).
- ◆ Recording may be unavailable at some settings, while in other cases settings may not apply during recording.
- ⓘ The microphone may pick up lens noise and other sounds made by the camera during recording.
- ⓘ Vertical or horizontal streaks may appear in movies containing very bright subjects. This is normal and does not indicate a malfunction.

### Depth of Field

Manual aperture adjustment is available in shooting modes **A** and **M**; adjust aperture before recording begins. Choose low f-numbers to soften background details. The effect can be heightened by increasing the distance between your subject and the background.

## Viewing Movies

During playback, movies are displayed as shown at right. The following operations can be performed while a movie is displayed:

Operation	Description
Start/pause playback	<b>Press the selector down</b> to start playback. Press again to pause. While playback is paused, you can press the selector left or right to rewind or advance one frame at a time.
End playback	<b>Press the selector up</b> to end playback.
Adjust speed	<b>Press the selector left or right</b> to adjust playback speed during playback.
Adjust volume	<b>Press MENU/OK</b> to pause playback and display volume controls. Press the selector up or down to adjust the volume; press <b>MENU/OK</b> again to resume playback. Volume can also be adjusted from the setup menu (📖 96).



Movie icon

Progress is shown in the display during playback.

- ⓘ Do not cover the speaker during playback.
- ⓘ Sound is not played back if **OFF** is selected for **SOUND & FLASH** (📖 95).

Progress bar



### Playback Speed

**Press the selector left or right** to adjust playback speed during playback. Speed is shown by the number of arrows (▶ or ◀).

Arrow



# The Q (Quick Menu) Button

## Using the Q Button

Press **Q** for quick access to selected options.

### The Quick Menu Display

At default settings, the quick menu contains the following items.

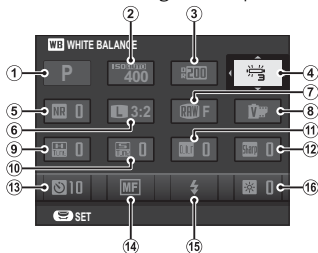

①	SHOOTING MODE	38	⑨	HIGHLIGHT TONE	84
②	ISO	67	⑩	SHADOW TONE	85
③	DYNAMIC RANGE	84	⑪	COLOR	84
④	WB WHITE BALANCE	58	⑫	SHARPNESS	84
⑤	NR NOISE REDUCTION	85	⑬	SELF-TIMER	63
⑥	IMAGE SIZE	83	⑭	FOCUS MODE	55
⑦	IMAGE QUALITY	83	⑮	FLASH MODE	71
⑧	FILM SIMULATION	73	⑯	LCD BRIGHTNESS	97

- ◆ The shooting mode is the current shooting mode and can not be changed from the quick menu.
- ◆ **CUSTOM** and **WHITE BALANCE** options can not be accessed using the **Q** button. Use a function button or the shooting menu.

### Viewing and Changing Settings

- 1 Press **Q** to display the quick menu during shooting.
- 2 Use the selector to highlight items and rotate the main/sub-command dial to change.
- 3 Press **Q** to exit when settings are complete.

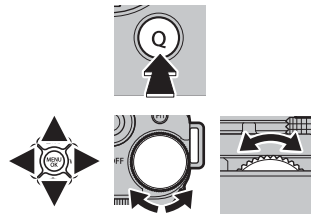

**Editing the Quick Menu**

To choose the items displayed in the quick menu:

- 1 Press and hold the **Q** button during shooting.

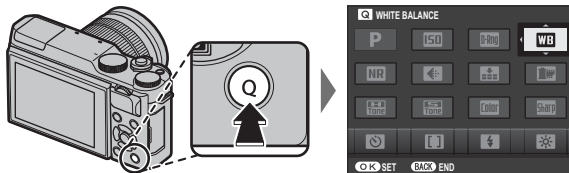

- 2 The current quick menu will be displayed; use the selector to highlight the item you wish to change and press **MENU/OK**. You will be given the following choice of items to assign to the selected position:

- ISO
- DYNAMIC RANGE
- WHITE BALANCE
- NOISE REDUCTION
- IMAGE SIZE
- IMAGE QUALITY
- FILM SIMULATION
- HIGHLIGHT TONE
- SHADOW TONE
- COLOR
- SHARPNESS
- SELF-TIMER
- FACE/EYE DETECTION SETTING
- PHOTOMETRY
- FOCUS MODE
- FLASH MODE
- FLASH COMPENSATION
- IS MODE
- MF ASSIST
- MOVIE MODE
- MOVIE ISO
- MIC LEVEL ADJUSTMENT
- SOUND & FLASH
- LCD BRIGHTNESS
- LCD COLOR
- SHUTTERTYPE
- NONE

◆ Select **NONE** to assign no option to the selected position.

- 3 Highlight the desired item and press **MENU/OK** to assign it to the selected position.

◆ The quick menu can also be edited using the **ⓘ BUTTON SETTING > EDIT/SAVE QUICK MENU** option in the setup menu (📖 98).

# The Fn (Function) Button

## Using the Function Button

The role played by the **Fn** button can be selected using the **DISP/BACK** **BUTTON** **SETTING > FUNCTION (Fn) SETTING** option in the setup menu.

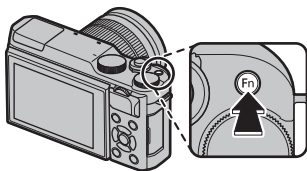

- PREVIEW DEPTH OF FIELD
- ISO
- SELF-TIMER
- IMAGE SIZE
- IMAGE QUALITY
- DYNAMIC RANGE
- FILM SIMULATION
- WHITE BALANCE
- PHOTOMETRY
- AE-LOCK
- AF-LOCK
- AE/AF LOCK
- INSTANT AF
- FOCUS MODE
- FOCUS AREA
- FLASH MODE
- FLASH COMPENSATION
- MOVIE
- FACE/EYE DETECTION SETTING
- RAW
- WIRELESS COMMUNICATION
- SHUTTERTYPE
- PREVIEW EXP. IN MANUAL MODE
- PREVIEW PIC. EFFECT
- NONE

🔑 To disable the selected button, choose **NONE**.

🔑 The **Fn** **FUNCTION (Fn) SETTING** menu can also be displayed by pressing and holding the **Fn** or **DISP/BACK** button.

## More on Photography and Playback

### Shooting Mode

Choose a shooting mode according to the scene or type of subject. To choose a shooting mode, rotate the mode dial to the desired setting. The following modes are available:

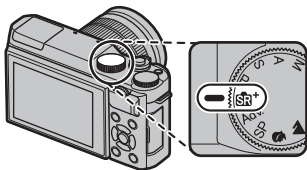

**P:** Aperture and shutter speed can be adjusted using program shift (📖 47).

**SR+ (ADVANCED SR AUTO):** The camera automatically optimizes settings to the scene (📖 39).

**Adv. (ADVANCED):** Sophisticated techniques made easy (📖 40).

**S, A, M:** Select for full control over camera settings, including aperture (**M** and **A**) and/or shutter speed (**M** and **S**) (📖 48, 49, 50).















**C (CUSTOM):** Recall stored settings for modes **P**, **S**, **A**, and **M** (📖 51).

**SP SCENE POSITION / 🌅 / 🏔️ / 🌊 / 🌃 / 🏠:** Choose a scene suited to the subject or shooting conditions and let the camera do the rest (📖 45).

**SR+ ADVANCED SR AUTO**

When the mode dial is rotated to **SR+**, the camera automatically optimizes settings to suit the scene.

The scene is shown by an icon in the display.

-  (  ) **AUTO**
-  (  ) **PORTRAIT**
-  (  ) **LANDSCAPE**
-  (  ) **NIGHT**
-  (  ) **MACRO**
-  (  ) **NIGHT PORTRAIT**
-  (  ) **BACKLIT PORTRAIT**

◆ The scenes in parentheses are selected if the camera detects that the subject is moving.

① The mode selected may vary with shooting conditions. If the mode and subject do not match, select mode **P** or choose **SP** (📖 45) and select a scene manually.







**Adv. ADVANCED**

This mode combines “point-and-shoot” simplicity with sophisticated photographic techniques.

◆  **Adv. MODE** supports exposure compensation (📖 69) and program shift (📖 47).

**1** Press **MENU/OK** while the mode description is displayed.

◆ If the view through the lens is displayed in the LCD monitor, press **MENU/OK** and select  **Adv. MODE** in the shooting menu.



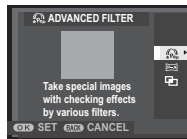
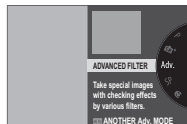











**2** Highlight  **ADVANCED FILTER** (📖 41),  **PANORAMA** (📖 42), or  **MULTIPLE EXPOSURE** (📖 44) and press **MENU/OK**.





## ■ ADVANCED FILTER

Take photos with filter effects. Choose from the following filters.

Filter	Description
 <b>TOY CAMERA</b>	Choose for a retro toy camera effect.
 <b>MINIATURE</b>	The tops and bottoms of pictures are blurred for a diorama effect.
 <b>POP COLOR</b>	Create high-contrast images with saturated colors.
 <b>HIGH-KEY</b>	Create bright, low-contrast images.
 <b>LOW-KEY</b>	Create uniformly dark tones with few areas of emphasized highlights.
 <b>DYNAMIC TONE</b>	Dynamic tone expression is used for a fantasy effect.
 <b>FISH-EYE</b>	Create a distorting effect of a fisheye lens.
 <b>SOFT FOCUS</b>	Create a look that is evenly soft throughout the whole image.
 <b>CROSS SCREEN</b>	Create a star pattern where lines radiate out from bright objects. The effects of the cross screen filter can be viewed after shooting.
 <b>PARTIAL COLOR (RED)</b>	Areas of the image that are the selected color are recorded in that color. All others areas of the image are recorded in black-and-white.
 <b>PARTIAL COLOR (ORANGE)</b>	
 <b>PARTIAL COLOR (YELLOW)</b>	
 <b>PARTIAL COLOR (GREEN)</b>	
 <b>PARTIAL COLOR (BLUE)</b>	
 <b>PARTIAL COLOR (PURPLE)</b>	

- Depending on the subject and camera settings, images may in some cases be grainy or vary in brightness and hue.

## ■ PANORAMA

Follow an on-screen guide to create a panorama.

- 1 To select the size of the angle through which you will pan the camera while shooting, press the selector left. Highlight a size and press **MENU/OK**.
- 2 Press the selector right to view a choice of pan directions. Highlight a pan direction and press **MENU/OK**.
- 3 Press the shutter button all the way down to start recording. There is no need to keep the shutter button pressed during recording.
- 4 Pan the camera in the direction shown by the arrow. Shooting ends automatically when the camera is panned to the end of the guides and the panorama is complete.
  - ◆ Shooting ends if the shutter button is pressed all the way down during shooting. No panorama may be recorded if the shutter button is pressed before the panorama is complete.

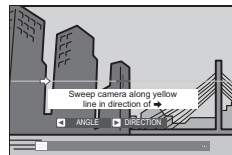

### For Best Results

For best results, use a lens with a focal length of 35 mm or less (50 mm or less in 35 mm format). Prop your elbows against your sides and move the camera slowly in a small circle at a steady speed, keeping the camera parallel or at right angles to the horizon and being careful only to pan in the direction shown by the guides. Use a tripod for best results. If the desired results are not achieved, try panning at a different speed.

- ❗ Panoramas are created from multiple frames; exposure for the entire panorama is determined by the first frame. The camera may in some cases record an greater or lesser angle than selected or be unable to stitch the frames together perfectly. The last part of the panorama may not be recorded if shooting ends before the panorama is complete.
- ❗ Shooting may be interrupted if the camera is panned too quickly or too slowly. Panning the camera in a direction other than that shown cancels shooting.
- ❗ The desired results may not be achieved with moving subjects, subjects close to the camera, unvarying subjects such as the sky or a field of grass, subjects that are in constant motion, such as waves and waterfalls, or subjects that undergo marked changes in brightness. Panoramas may be blurred if the subject is poorly lit.

### Viewing Panoramas

In full-frame playback, you can use the sub-command to zoom panoramas in or out. Alternatively, you can play the panorama back using the selector. Press the selector down to start playback and press again to pause. While playback is paused, you can scroll the panorama manually by pressing the selector left or right; vertical panoramas will scroll vertically, horizontal panoramas horizontally. To exit to full-frame playback, press the selector up.

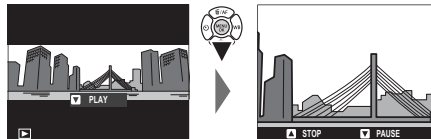

## ■ MULTIPLE EXPOSURE

Create a photograph that combines two exposures.



**1** Take the first shot.

**2** Press **MENU/OK**. The first shot will be shown superimposed on the view through the lens as a guide to taking the second shot.





◆ To return to Step 1 and retake the first shot, press the selector left. To save the first shot and exit without creating a multiple exposure, press **DISP/BACK**.

**3** Take the second shot.

**4** Press **MENU/OK** to create the multiple exposure, or press the selector left to return to Step 3 and retake the second shot.

**SP SCENE POSITION** /  /  /  /  / 

The camera offers a choice of “scenes,” each adapted to particular shooting conditions or a specific type of subject. The following scenes can be selected directly using the mode dial:

Scene	Description
 <b>PORTRAIT ENHANCER</b> (🔒)	Choose for a smooth skin effect when shooting portraits.
 <b>LANDSCAPE</b>	Choose for daylight shots of buildings and landscapes.
 <b>SPORT</b>	Choose when photographing moving subjects.
 <b>NIGHT</b>	Choose for poorly lit twilight or night scenes.



Other scenes can be selected by rotating the mode dial to **SP** and following the steps below.







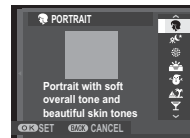
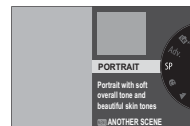

**1** Press **MENU/OK** while the mode description is displayed.

- ◆ If the view through the lens is displayed in the LCD monitor, press **MENU/OK** and select  **SCENE POSITION** in the shooting menu.

**2** Highlight one of the following options and press **MENU/OK**.



## Shooting Mode

Scene	Description
 <b>PORTRAIT</b>	Choose for portraits.
 <b>NIGHT (TRIPOD)</b>	Choose this mode for slow shutter speeds when shooting at night.
 <b>FIREWORKS</b>	Slow shutter speeds are used to capture the expanding burst of light from a firework.
 <b>SUNSET</b>	Choose this mode to record the vivid colors in sunrises and sunsets.
 <b>SNOW</b>	Choose for crisp, clear shots that capture the brightness of scenes dominated by shining white snow.
 <b>BEACH</b>	Choose for crisp, clear shots that capture the brightness of sunlit beaches.
 <b>PARTY</b>	Capture indoor background lighting under low-light conditions.
 <b>FLOWER</b>	Effective for taking more vivid shots of flowers.
 <b>TEXT</b>	Take clear pictures of text or drawings in print.

**Program AE (P)**

In this mode, the camera adjusts shutter speed and aperture for optimal exposure.



### Program Shift

Rotate the sub-command dial to choose the desired combination of shutter speed and aperture (program shift). The new values for shutter speed and aperture are shown in yellow. Program shift is not available if an auto option is selected for **D-Rng DYNAMIC RANGE** in the shooting menu (84). To cancel program shift, turn the camera off.

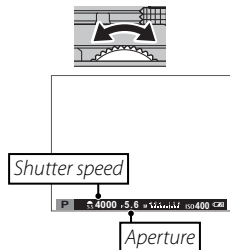

◆ For information on the roles of the main and sub-command dials, see page 4.

**Shutter-Priority AE (S)**

In this mode, you choose the shutter speed by rotating the sub-command dial, while the camera adjusts aperture for optimal exposure.

◆ For information on the roles of the main and sub-command dials, see page 4.

- ① If the correct exposure can not be achieved at the selected shutter speed, aperture will be displayed in red when the shutter button is pressed halfway. Adjust shutter speed until the correct exposure is achieved.



### **Long Time-Exposures**

Shutter speeds of 1 s or slower are referred to as “long time-exposures”.



- ◆ Use of a tripod is recommended to prevent the camera from moving during the exposure.
- ◆ A count-down timer will be displayed while the exposure is in progress.
- ◆ To reduce “noise” (mottling) in long time-exposures, select **ON** for **LONG EXPOSURE NR** in the shooting menu (85). Note that this may increase the time needed to record images after shooting.
- ◆ An optional RR-90 remote release can be used for long time-exposures.



## Aperture-Priority AE (A)

In this mode, you choose the aperture by rotating the sub-command dial, while the camera adjusts shutter speed for optimal exposure.

- ◆ For information on the roles of the main and sub-command dials, see page 4.
- ① If the correct exposure can not be achieved at the selected aperture, the shutter speed will be displayed in red when the shutter button is pressed halfway. Adjust aperture until the correct exposure is achieved.



### Previewing Depth of Field

When **PREVIEW DEPTH OF FIELD** is assigned to a function button (37), pressing the button stops aperture down to the selected setting, allowing depth of field to be previewed in the display.

Depth of field can also be previewed using the depth-of-field indicator in the standard display when **AF DISTANCE INDICATOR/MF DISTANCE INDICATOR** is selected in the **SCREEN SET-UP > DISP. CUSTOM SETTING** menu. Press **DISP/BACK** to select standard indicators.

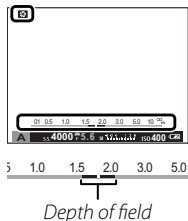



**Manual Exposure (M)**

In this mode, you control both shutter speed and aperture. Rotate the main command dial to choose a shutter speed and the sub-command dial to choose the aperture.

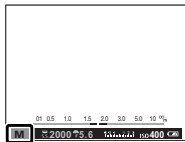

- ◆ For information on the roles of the main and sub-command dials, see page 4.
- ◆ The manual exposure display includes an exposure indicator that shows the amount the picture would be under- or over-exposed at current settings.

**Exposure Preview**

To preview exposure in the LCD monitor, select **ON** for  **SCREEN SET-UP > PREVIEW EXP. IN MANUAL MODE**. Select **OFF** when using the flash or on other occasions on which exposure may change when the picture is taken.

**Bulb Photography**

For bulb photography, rotate the main command dial to select a shutter speed of **BULB**.

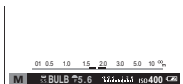





















- ◆ Use of a tripod is recommended to prevent the camera from moving during the exposure.
- ◆ A count-down timer will be displayed while the exposure is in progress.
- ◆ To reduce “noise” (mottling) in long time-exposures, select **ON** for  **LONG EXPOSURE NR** in the shooting menu (85). Note that this may increase the time needed to record images after shooting.
- ◆ An optional RR-90 remote release can be used for long time-exposures.

**Custom Mode (C)**

In **P**, **S**, **A**, and **M** modes, the  **CUSTOM SET** option in the shooting menu can be used to save current camera and menu settings. These settings are recalled whenever the mode dial is rotated to **C** (custom mode).







Menu/setting	Settings saved
Shooting menu	 <b>AF/MF SETTING (FOCUS MODE/FACE/EYE DETECTION SETTING)</b> ,  <b>ISO</b> ,  <b>IMAGE SIZE</b> ,  <b>IMAGE QUALITY</b> ,  <b>DYNAMIC RANGE</b> ,  <b>FILM SIMULATION</b> ,  <b>SELF-TIMER</b> ,  <b>WHITE BALANCE</b> ,  <b>COLOR</b> ,  <b>SHARPNESS</b> ,  <b>HIGHLIGHT TONE</b> ,  <b>SHADOW TONE</b> ,  <b>NOISE REDUCTION</b> ,  <b>MF ASSIST</b> ,  <b>PHOTOMETRY</b> ,  <b>FLASH SET-UP (FLASH MODE/FLASH COMPENSATION)</b> ,  <b>MOVIE SET-UP (MOVIE MODE/MOVIE ISO/FOCUS MODE/MIC LEVEL ADJUSTMENT)</b> ,  <b>IS MODE</b> ,  <b>SHUTTER TYPE</b>
Setup Menu	 <b>SOUND &amp; FLASH</b> ,  <b>SCREEN SET-UP (LCD BRIGHTNESS/LCD COLOR)</b>
Other	Shutter speed, Aperture

## Focus Mode

Choose how the camera focuses (note that regardless of the option selected, manual focus will be used when a manual focus lens is attached).

- 1 Press **MENU/OK** in shooting mode to display the shooting menu, then select **AF/MF SETTING**, highlight **FOCUS MODE**, and press **MENU/OK**.
- 2 Press the selector up or down to highlight the desired option and press **MENU/OK** to select.

Option	Description
 <b>MANUAL</b>	Choose for manual control of focus or in situations in which the camera is unable to focus using autofocus (see 53).
 <b>MULTI</b>	When the shutter button is pressed halfway, the camera detects high-contrast subjects near the center of the frame and selects the focus area automatically. The selected focus areas are highlighted in the display.
 <b>AREA</b>	Choose the focus area manually (see 55).
 <b>CONTINUOUS</b>	The camera continuously adjusts focus to reflect changes in the distance to the subject in the focus frame.
 <b>TRACKING</b>	Position the subject in the focus target and press the selector left. The camera will track the subject and adjust focus as it moves through the frame.

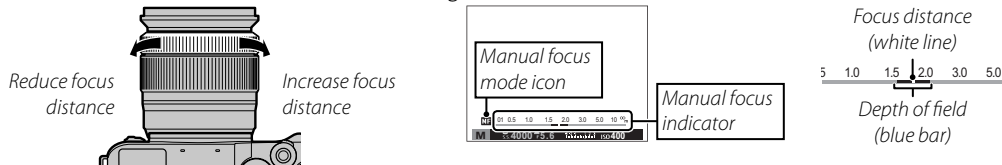

## MF MANUAL

When **MF MANUAL** is selected for **RF AF/MF SETTING > FOCUS MODE**, you can focus manually using the lens focus ring. Rotate the ring left to reduce the focus distance, right to increase. The manual focus indicator indicates how closely the focus distance matches the distance to the subject in the focus brackets (the white line indicates the focus distance, the blue bar the depth of field, or in other words the distance in front of and behind the focus point that appears to be in focus); you can also check focus visually in the viewfinder or LCD monitor. Choose for manual control of focus or in situations in which the camera is unable to focus using autofocus (📖 57).



- Use the **FOCUS RING** option in the setup menu (📖 98) to reverse the direction of rotation of the focus ring.
- INSTANT AF** can be assigned to the **Fn** button, allowing the button to be used to quickly focus on the subject in the selected focus frame when the camera is in manual focus mode.
- Selecting **FOCUS PEAK HIGHLIGHT** for **MF ASSIST** highlights high-contrast outlines. Rotate the focus ring until the subject is highlighted. The **MF ASSIST** menu can be displayed by pressing and holding the center of the sub-command dial.
- The camera can show focus distance in meters or feet. Use the **SCREEN SET-UP > FOCUS SCALE UNITS** option in the setup menu (📖 97) to choose the units used.

## ■ The Focus Indicator

The focus indicator turns green when the subject is in focus and blinks white when the camera is unable to focus. Brackets (“( )”) indicate that the camera is focusing; if  **CONTINUOUS** or  **TRACKING** is selected for **AF/MF SETTING > FOCUS MODE**, the brackets will be displayed continuously while the shutter button is pressed halfway. **MF** is displayed in manual focus mode.

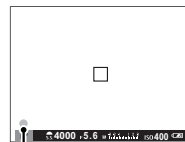



Focus indicator

### Checking Focus

In manual focus mode, you can press the center of the sub-command dial to magnify the view in the LCD monitor. To view other areas of the frame, press the selector up (**AF**) and then use the selector to scroll the display. Press again to cancel zoom. If **ON** is selected for  **SCREEN SET-UP > FOCUS CHECK**, the camera will automatically zoom in on the selected focus area when the focus ring is rotated.



### Focus-Point Selection

When  **AREA** is selected for  **AF/MF SETTING** > **FOCUS MODE**, the camera offers a choice of focus points allowing photographs to be composed with the main subject positioned almost anywhere in the frame. Press the selector up (**AF**) and then use the selector to position the focus frame (the focus frame can be returned to the center by pressing **DISP/BACK**). Press **MENU/OK** to put the setting into effect.

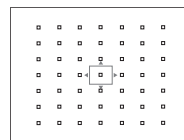
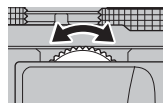
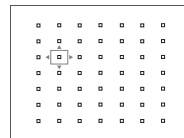
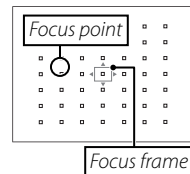
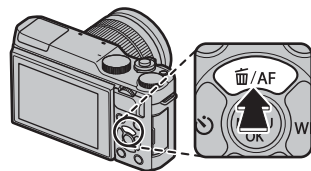

To choose the size of the focus frame, press the selector up (**AF**) and rotate the sub-command dial. Rotate the dial left to reduce the frame by up to 50%, right to enlarge it by up to 150%, or press the center of the dial to restore the frame to its original size. Press **MENU/OK** to put the setting into effect.

## Focus/Exposure Lock

To compose photographs with off-center subjects:

**1 Focus:** Position the subject in the focus frame and press the shutter button halfway to lock focus and exposure. Focus and exposure will remain locked while the shutter button is pressed halfway (AF/AE lock).

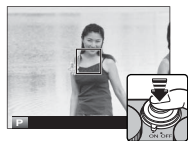

◆ If **AE-LOCK**, **AF-LOCK**, or **AE/AF LOCK** is assigned to the **Fn** button, the focus and/or exposure will lock while the **Fn** button is pressed and remain locked even when the shutter button is pressed halfway.

**2 Recompose:** Keep the shutter button pressed halfway or keep the **Fn** button pressed.



**3 Shoot:** Press the button all the way down.













 **Autofocus**

Although the camera boasts a high-precision autofocus system, it may be unable to focus on the subjects listed below.

- Very shiny subjects such as mirrors or car bodies.
- Subjects photographed through a window or other reflective object.
- Dark subjects and subjects that absorb rather than reflect light, such as hair or fur.
- Insubstantial subjects, such as smoke or flame.
- Subjects that show little contrast with the background.
- Subjects positioned in front of or behind a high-contrast object that is also in the focus frame (for example, a subject photographed against a backdrop of highly contrasting elements).

## White Balance

For natural colors, press the selector right (**WB**) to display the following options, then use the selector to highlight an option that matches the light source and press **MENU/OK**. The dialog shown at bottom right will be displayed; use the selector to fine-tune white balance or press **DISP/BACK** to exit without fine-tuning.

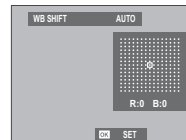

Option	Description	Option	Description
<b>AUTO</b>	White balance adjusted automatically.		Use under "daylight" fluorescent lights.
	Measure a value for white balance (📖 59).		Use under "warm white" fluorescent lights.
	Selecting this option displays a list of color temperatures (📖 59); highlight a temperature and press <b>MENU/OK</b> to select the highlighted option and display the fine-tuning dialog.		Use under "cool white" fluorescent lights.
			Use under incandescent lighting.
	For subjects in direct sunlight.		Reduces the blue cast typically associated with underwater lighting.
	For subjects in the shade.		



- 🔍 White balance is adjusted for flash lighting only in **AUTO** and  modes. Turn the flash off using other white balance options.
- 🔍 Results vary with shooting conditions. Play pictures back after shooting to check colors.
- 🔍 White balance options can also be accessed from the shooting menu (📖 84).

### Custom White Balance

Choose  to adjust white balance for unusual lighting conditions. White balance measurement options will be displayed; frame a white object so that it fills the display and press the shutter button all the way down to measure white balance (to select the most recent custom value and exit without measuring white balance, press **DISP/BACK**, or press **MENU/OK** to select the most recent value and display the fine-tuning dialog).

- If **"COMPLETED!"** is displayed, press **MENU/OK** to set white balance to the measured value.
- If **"UNDER"** is displayed, raise exposure compensation ( 69) and try again.
- If **"OVER"** is displayed, lower exposure compensation ( 69) and try again.

### Color Temperature

Color temperature is an objective measure of the color of a light source, expressed in Kelvin (K). Light sources with a color temperature close to that of direct sunlight appear white; light sources with a lower color temperature have a yellow or red cast, while those with a higher color temperature are tinged with blue. You can match color temperature to the light source as shown in the following table, or choose options that differ sharply from the color of the light source to make pictures "warmer" or "colder."

◀ Choose for redder light sources  
or "colder" pictures

Choose for bluer light sources  
or "warmer" pictures ▶

2,000 K

Candlelight

Sunset/sunrise

5,000 K

Direct sunlight

Shade

15,000 K

Blue sky

## Burst Mode and Bracketing



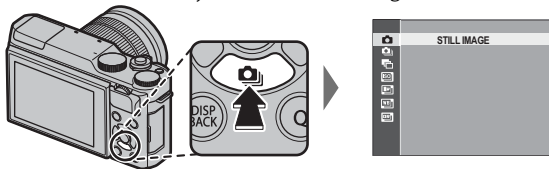



To access burst shooting and bracketing options, press the selector down when the camera is in shooting mode. The options available vary with the shooting mode.



Option	Available in	
STILL IMAGE	All modes	—
CONTINUOUS	<b>SR<sup>+</sup>, P, S, A, M, S, ▲, ✂, C, SP</b>	61
AE BKT	<b>P, S, A, M</b>	62
ISO BKT	<b>P, S, A, M</b>	62
FILM SIMULATION BKT	<b>P, S, A, M</b>	62
WHITE BALANCE BKT	<b>P, S, A, M</b>	62
DYNAMIC RANGE BKT	<b>P, S, A, M</b>	62

**Continuous Shooting (Burst Mode)**

Capture motion in a series of pictures.

- 1 Press the selector down () when the camera is in shooting mode.
- 2 Press the selector up or down to choose , and press left or right to choose from frame rates of  (high) or  (low). Press **MENU/OK** to proceed when settings are complete.
- 3 Press the shutter button halfway to focus. 
- 4 Press the shutter button the rest of the way down to start shooting. Shooting ends when the shutter button is released, the selected number of pictures has been taken, or the memory card is full. 

- ◆ Focus and exposure are determined by the first frame in each series. The flash turns off automatically; the previously-selected flash mode is restored when burst shooting is turned off.
- ◆ Frame rate varies with shutter speed and may slow as more shots are taken.
- ◆ Additional time may be required to record pictures when shooting ends.
- ◆ If file numbering reaches 999 before shooting is complete, the remaining pictures will be recorded to a new folder ( 99).
- ◆ Burst shooting may not begin if the space available on the memory card is insufficient.

**Bracketing**

Automatically vary settings over a series of pictures.

- 1 Press the selector down (⏏) when the camera is in shooting mode, and then press the selector up or down to highlight one of the following:





Option	Description
<b>AE BKT</b>	Press the selector left or right to highlight a bracketing amount. Each time the shutter button is pressed, the camera will take three shots: one using the metered value for exposure, the second overexposed by the selected amount, and the third underexposed by the same amount (regardless of the amount selected, exposure will not exceed the limits of the exposure metering system).
<b>ISO BKT</b>	Press the selector left or right to highlight a bracketing amount. Each time the shutter is released, the camera will take a picture at the current sensitivity (📖 67) and process it to create two additional copies, one with sensitivity raised and the other with sensitivity lowered by the selected amount (regardless of the amount selected, sensitivity will not exceed ISO 6400 or fall below ISO 200).
<b>FILM SIMULATION BKT</b>	Each time the shutter is released, the camera takes one shot and processes it to create copies with the film simulation settings selected for 📖 <b>FILM SIMULATION BKT</b> in the shooting menu (📖 84).
<b>WHITE BALANCE BKT</b>	Press the selector left or right to choose the bracketing amount. Each time the shutter button is pressed, the camera takes three shots: one at the current white balanced setting, one with fine-tuning increased by the selected amount, and another with fine-tuning decreased by the selected amount.
<b>DYNAMIC RANGE BKT</b>	Each time the shutter button is pressed, the camera takes three shots with different dynamic ranges (📖 84): 100% for the first, 200% for the second, and 400% for the third. While dynamic range bracketing is in effect, sensitivity will be restricted to a minimum of ISO 800 (or to a minimum of ISO 200 to 800 when an auto option is selected for sensitivity); the sensitivity previously in effect is restored when bracketing ends.

- 2 Press **MENU/OK** to select the highlighted option.
- 3 Take photographs.

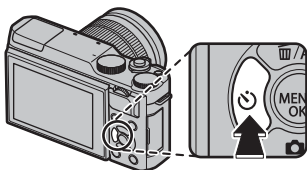

## Using the Self-Timer

Use the timer for group- or self-portraits, to prevent blur caused by camera shake, or to release the shutter automatically when selected conditions are met. To use the self-timer, press the selector left when the camera is in shooting mode. The options shown below will be displayed; press the selector up or down to highlight an option and press **MENU/OK** to select.

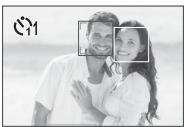
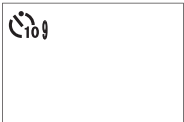

Option	Description
 <b>2 SEC</b>	The shutter is released two or ten seconds after the shutter button is pressed. Press the shutter button halfway to focus, then press it the rest of the way down to start the timer. The display in the monitor shows the number of seconds remaining until the timer is released; immediately before the shutter is released, the self-timer lamp on the front of the camera will blink (if the two-second timer is selected, the lamp will blink as the timer counts down). Use the two-second timer to reduce blur caused by the camera moving when the shutter button is pressed, the ten-second timer for photographs in which you wish to appear yourself.
 <b>10 SEC</b>	① Stand behind the camera when using the shutter button. Standing in front of the lens can interfere with focus and exposure.
 <b>SMILE</b>	The camera detects faces (82) and releases the shutter when any subject smiles. The camera may fail to detect subjects who are not facing the camera or whose faces are obscured by hair or other objects.
 <b>BUDDY</b>	The camera starts the timer when it detects two portrait subjects close together. When prompted to choose how close together the subjects must be before the timer starts, highlight the desired option and press <b>MENU/OK</b> (the required degree of closeness is shown by heart icons in the shooting display: the more hearts, the closer together the subjects must be). Choose from <b>LV.1 (NEAR)</b> , <b>LV.2 (CLOSE UP)</b> , or <b>LV.3 (SUPER CLOSE)</b> . The timer starts only when the subjects are sufficiently close together; the shutter is released one second later.



Option	Description
 <b>GROUP</b>	The camera starts the timer when it detects the selected number of portrait subjects. Highlight the desired number of subjects (1 to 4) and press <b>MENU/OK</b> (the number of subjects is indicated by  icons in the shooting display). The timer starts only when the selected number of subjects is in the frame; the shutter is released two seconds later. 
<b>OFF</b>	Self-timer off.

To stop the timer before the picture is taken, press **DISP/BACK**.

- ◆ Self-timer options can also be selected in the shooting menu.
- ◆ Selecting  **SMILE**,  **BUDDY**, or  **GROUP** sets **AF/MF SETTING > FACE/EYE DETECTION SETTING** to **FACE ON/EYE OFF**. The original setting is restored when the self timer is turned off.
- ◆ The self-timer turns off automatically when the camera is turned off.



## Interval Timer Photography

Follow the steps below to configure the camera to take photos automatically at a preset interval.

- 1 Press **MENU/OK** in shooting mode to display the shooting menu. Press the selector up or down to highlight  **INTERVAL TIMER SHOOTING** and press **MENU/OK**.
- 2 Use the selector to choose the interval and number of shots. Press **MENU/OK** to proceed.
- 3 Use the selector to choose the starting time and then press **MENU/OK**. Shooting will start automatically.

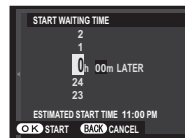
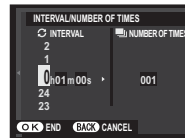

- ① Interval timer photography can not be used at a shutter speed of **B** (bulb) or during panorama or multiple exposure photography. In burst mode, only one picture will be taken each time the shutter is released.
- ◆ Use of a tripod is recommended.
- ◆ Check the battery level before starting. We recommend using an optional AC-9V AC power adapter and CP-W126 DC coupler.
- ◆ The display turns off between shots and lights a few seconds before the next shot is taken. The display can be activated at any time by pressing the shutter button all the way down.

## Self-Portraits (SELFIE)

To shoot a self-portrait, rotate the LCD monitor as shown.

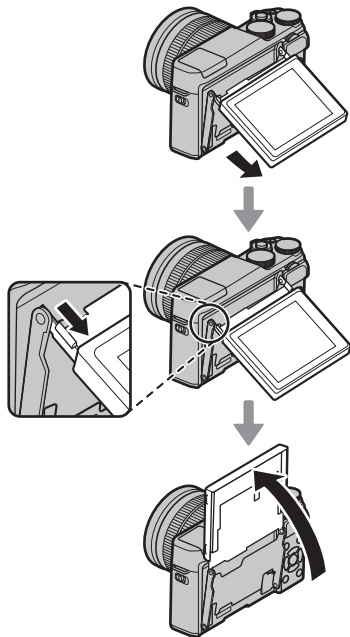

- Rotating the LCD monitor 180° automatically sets **AF/MF SETTING > FACE/EYE DETECTION SETTING** to **FACE ON/EYE AUTO** (82). The LCD monitor shows a mirror image of the view through the lens, and you can release the shutter by pressing the center of the sub-command dial. Regardless of the option selected for **SCREEN SET-UP > IMAGE DISP.**, pictures will be displayed for 1.5 seconds after shooting (96).

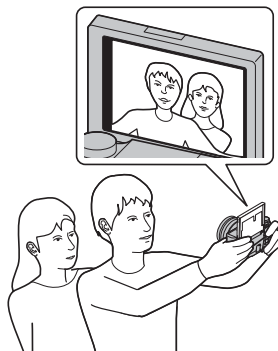

## Sensitivity

“Sensitivity” refers to the camera’s sensitivity to light. Choose from values between 200 and 6400, or select **L (100)**, **H (12800)**, or **H (25600)** for special situations. Higher values can be used to reduce blur when lighting is poor, while lower values allow slower shutter speeds or wider apertures in bright light; note, however, that mottling may appear in pictures taken at high sensitivities, particularly at **H (25600)**, while choosing **L (100)** reduces dynamic range. Values of from ISO 200 to ISO 6400 are recommended in most situations. If **AUTO1**, **AUTO2**, or **AUTO3** is selected, the camera will adjust sensitivity automatically in response to shooting conditions.

**1** Press **MENU/OK** in shooting mode to display the shooting menu. Press the selector up or down to highlight **ISO ISO** and press **MENU/OK**.

**2** Press the selector up or down to highlight the desired option and press **MENU/OK** to select.

- ◆ Sensitivity is not reset when the camera is turned off.
- ◆ **L (100)** is reset to ISO 200 and **H (12800)** and **H (25600)** are reset to ISO 6400 when **RAW**, **FINE+RAW**, or **NORMAL+RAW** is selected for image quality (83). For more information on the settings available with **L (100)**, **H (12800)**, and **H (25600)**, see page 137.

## ■ AUTO

The following options are available when **AUTO1**, **AUTO2**, or **AUTO3** is selected:

Option	Default
<b>DEFAULT SENSITIVITY</b>	200
<b>MAX. SENSITIVITY</b>	800 ( <b>AUTO1</b> ) 1600 ( <b>AUTO2</b> ) 3200 ( <b>AUTO3</b> )
<b>MIN. SHUTTER SPEED</b>	1/60

The camera automatically chooses a sensitivity between the default and maximum values. Sensitivity is only raised above the default value if the shutter speed required for optimal exposure would be slower than the value selected for **MIN. SHUTTER SPEED**.

- 🔍 If the value selected for **DEFAULT SENSITIVITY** is higher than that selected for **MAX. SENSITIVITY**, **DEFAULT SENSITIVITY** will be set to the value selected for **MAX. SENSITIVITY**.
- 🔍 The camera may select shutter speeds slower than **MIN. SHUTTER SPEED** if pictures would still be underexposed at the value selected for **MAX. SENSITIVITY**.

## Exposure Compensation

Rotate the main command dial to adjust exposure when photographing very bright, very dark, or high-contrast subjects. The effect is visible in the display.

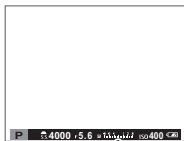

Exposure compensation indicator

Rotate the dial right to choose higher values and increase exposure



Rotate the dial left to choose lower values and reduce exposure



### Exposure Value (EV)

The exposure value is determined by the sensitivity of the image sensor and the amount of light to which the sensor is exposed. Doubling the amount increases EV by one, while halving it reduces EV by one. The amount of light entering the camera can be controlled by adjusting aperture and shutter speed.

### Choosing an Exposure Compensation Value

- **Backlit subjects:** Choose values from  $+2/3$  EV to  $+12/3$  EV.



- **Highly reflective subjects or very bright scenes** (e.g., snowfields):  $+1$  EV



- **Scenes that are mostly sky:**  $+1$  EV



- **Spotlit subjects** (particularly if photographed against dark backgrounds):  $-2/3$  EV

- **Subjects with low reflectivity** (pine trees or dark-colored foliage):  $-2/3$  EV

## Metering

Choose how the camera meters exposure.

- 1 Press **MENU/OK** in shooting mode to display the shooting menu. Press the selector up or down to highlight  **PHOTOMETRY** and press **MENU/OK**.
- 2 Press the selector up or down to highlight the desired option and press **MENU/OK** to select.

Mode	Description
 (MULTI)	The camera instantly determines exposure based on an analysis of composition, color, and brightness distribution. Recommended in most situations.
 (SPOT)	The camera meters lighting conditions in an area at the center of the frame equivalent to 2% of the total. Recommended with backlit subjects and in other cases in which the background is much brighter or darker than the main subject.
 (AVERAGE)	Exposure is set to the average for the entire frame. Provides consistent exposure across multiple shots with the same lighting, and is particularly effective for landscapes and portraits of subjects dressed in black or white.

- ① The selected option will only take effect when **FACE OFF/EYE OFF** is selected for **AF AF/MF SETTING > FACE/EYE DETECTION SETTING** ( 82).







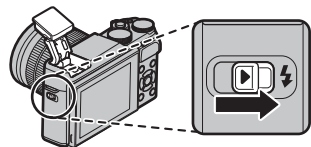

## Using the Flash

Use the built-in flash for additional lighting when shooting at night or indoors under low light.

- 1 Slide the  (flash pop-up) switch to raise the flash.



- 2 Select  **FLASH SET-UP** > **FLASH MODE** in the shooting menu. The options shown below will be displayed; press the selector up or down to highlight an option and press **MENU/OK** to select.

Mode	Description
<b>AUTO</b> (AUTO FLASH)/  (RED EYE REDUCTION)*	The flash fires when required. Recommended in most situations.
 (FORCED FLASH)/  (FORCED FLASH)*	The flash fires whenever a picture is taken. Use for backlit subjects or for natural coloration when shooting in bright light.
<b>S</b>  (SLOW SYNCHRO)/  (RED EYE & SLOW)*	Capture both the main subject and the background under low light (note that brightly lit scenes may be overexposed).
 (2ND CURTAIN SYNC.)/  (2ND CURTAIN SYNC.)*	The flash fires immediately before the shutter closes.
 (COMMANDER)	The built-in flash can be used to control optional remote flash units.
 (SUPPRESSED FLASH)	The flash does not fire even when the subject is poorly lit. A tripod is recommended.

\* Red-eye removal is available in these modes when Intelligent Face Detection is active (🗨 82) and red-eye removal is on (🗨 86). Red-eye removal minimizes “red-eye” caused when light from the flash is reflected from the subject’s retinas as shown in the illustration at right.



- ① Depending on the distance to the subject, some lenses may cast shadows in photos taken with the flash.
- 🔍 Lowering the flash turns the flash off (🚫) and prevents it firing even when the subject is poorly lit; use of a tripod is recommended. Lower the flash where flash photography is prohibited or to capture natural lighting under dim light. We also recommend that you lower the flash when the camera is off.
- 🔍 If 📷 is displayed when the shutter button is pressed halfway, the flash will fire when the photo is taken.
- 🔍 Except in commander mode, the flash may fire several times with each shot. Do not move the camera until shooting is complete.

### Flash Sync Speed







The flash will synchronize with the shutter at shutter speeds of  $\frac{1}{180}$ s or slower.



## Film Simulation

Simulate the effects of different kinds of film, including black-and-white.

- 1 Press **MENU/OK** in shooting mode to display the shooting menu. Press the selector up or down to highlight  **FILM SIMULATION** and press **MENU/OK**.
- 2 Press the selector up or down to highlight one of the following options and press **MENU/OK** to select.

Option	Description
 (PROVIA/STANDARD)	Standard color reproduction. Suited to a wide range of subjects, from portraits to landscapes.
 (Velvia/VIVID)	A high-contrast palette of saturated colors, suited to nature photos.
 (ASTIA/SOFT)	Enhances the range of hues available for skin tones in portraits while preserving the bright blues of daylight skies. Recommended for outdoor portrait photography.
 (CLASSIC CHROME)	Soft color and enhanced shadow contrast for a calm look.
 (MONOCHROME)	Take pictures in standard black and white.
 (SEPIA)	Take pictures in sepia.

-  Film simulation options can be combined with tone and sharpness settings (📖 84, 85).

## Recording Pictures in RAW Format

To record raw, unprocessed data from the camera image sensor, select a **RAW** option for image quality in the shooting menu as described below. JPEG copies of RAW images can be created using the **RAW RAW CONVERSION** option in the playback menu, or RAW images can be viewed on a computer using the RAW FILE CONVERTER application (📖 107).

- 1 Press **MENU/OK** in shooting mode to display the shooting menu. Press the selector up or down to highlight **IMAGE QUALITY** and press **MENU/OK**.
- 2 Highlight an option and press **MENU/OK**. Select **RAW** to record only RAW images, or **FINE+RAW** or **NORMAL+RAW** to record both JPEG copy together with the RAW images. **FINE+RAW** uses lower JPEG compression ratios for higher-quality JPEG images, while **NORMAL+RAW** uses higher JPEG compression ratios to increase the number of images that can be stored.

### The Fn Button

To toggle RAW image quality on or off for a single shot, assign **RAW** to the **Fn** button. If a JPEG option is currently selected for image quality, pressing the **Fn** button temporarily selects the equivalent JPEG+RAW option. If a JPEG+RAW option is currently selected, pressing the **Fn** button temporarily selects the equivalent JPEG option, while if **RAW** is selected, pressing the **Fn** button temporarily selects **FINE**. Taking a picture or pressing the **Fn** button again restores the previous setting.

🔍 Sensitivities of **L (100)**, **H (12800)**, and **H (25600)** are not available when RAW image quality is on (📖 67).

## Creating JPEG Copies of RAW Pictures

RAW pictures store information on camera settings separately from the data captured by the camera image sensor. Using the **RAW RAW CONVERSION** option in the playback menu, you can create JPEG copies of RAW pictures using different options for the settings listed below. The original image data are unaffected, allowing a single RAW image to be processed in a multitude of different ways.

- 1 Press **MENU/OK** during playback to display the playback menu, then press the selector up or down to highlight **RAW RAW CONVERSION** and press **MENU/OK** to display the settings listed in the table at right.

◆ These options can also be displayed by pressing **Q** button during playback.

- 2 Press the selector up or down to highlight a setting and press the selector right to select. Press the selector up or down to highlight the desired option and press **MENU/OK** to select and return to the settings list. Repeat this step to adjust additional settings.

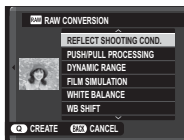

- 3 Press the **Q** button to preview the JPEG copy and press **MENU/OK** to save.

Setting	Description
<b>REFLECT SHOOTING COND.</b>	Create a JPEG copy using the settings in effect at the time the photo was taken.
<b>PUSH/PULL PROCESSING</b>	Adjust exposure by $-1$ EV to $+3$ EV in increments of $\frac{1}{2}$ EV (86 69).
<b>DYNAMIC RANGE</b>	Enhance details in highlights for natural contrast (86 84).
<b>FILM SIMULATION</b>	Simulate the effects of different types of film (86 73).
<b>WHITE BALANCE</b>	Adjust white balance (86 58).
<b>WB SHIFT</b>	Fine-tune white balance (86 58).
<b>COLOR</b>	Adjust color density (86 84).
<b>SHARPNESS</b>	Sharpen or soften outlines (86 84).
<b>HIGHLIGHT TONE</b>	Adjust highlights (86 84).
<b>SHADOW TONE</b>	Adjust shadows (86 85).
<b>NOISE REDUCTION</b>	Process the copy to reduce mottling (86 85).
<b>COLOR SPACE</b>	Choose the color space used for color reproduction (86 100).

## Using a Mount Adapter

When M-mount lenses are attached using an optional **FUJIFILM M MOUNT ADAPTER**, the camera processes pictures as they are taken to maintain image quality and correct for a variety of effects.

- ◆ Attaching a mount adapter enables **LENS SHOOT WITHOUT LENS** (85) and hides the distance indicator in the standard display.
- ◆ To check focus, select **MF MANUAL** for **AF AF/MF SETTING > FOCUS MODE** in the shooting menu (52).

### Mount Adapter Settings

Pressing the function button on the mount adapter displays **LENS MOUNT ADAPTOR SETTING** options.

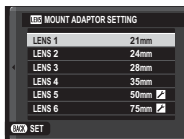

### Choosing a Focal Length

If the lens has a focal length of 21, 24, 28, or 35 mm, choose a matching option in the **LENS MOUNT ADAPTOR SETTING** menu. For other lenses, select option 5 or 6 to display the menu at right, press the selector right to display focal length settings, and use the selector to enter the focal length.

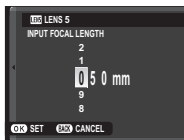

### Distortion Correction

Choose from **STRONG, MEDIUM, or WEAK** options to correct **BARREL** or **PINCUSHION** distortion.

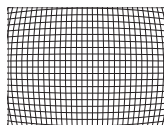
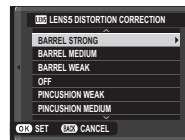

Barrel distortion

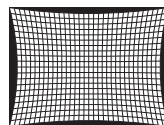

Pincushion distortion

- ◆ To determine the amount required, adjust distortion correction while taking photos of graph paper or other objects featuring repeating vertical and horizontal lines, such as the windows in a high-rise.

## ■ Color Shading Correction

Color (shading) variations between the center and edges of the frame can be adjusted separately for each corner.

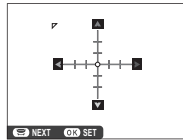

To use color shading correction, follow the steps below.

- 1 Rotate the sub-command dial to choose a corner. The selected corner is indicated by a triangle.



- 2 Use the selector to adjust shading until there is no visible difference in color between the selected corner and the center of the image. Press the selector left or right to adjust colors on the cyan-red axis, up or down to adjust colors on the blue-yellow axis. There are a total of 19 positions available on each axis.



- ◆ To determine the amount required, adjust color shading correction while taking photos of blue sky or a sheet of gray paper.

## ■ Peripheral Illumination Correction

Choose from values between  $-5$  and  $+5$ . Choosing positive values increases peripheral illumination, while choosing negative values reduces peripheral illumination. Positive values are recommended for vintage lenses, negative values to create the effect of images taken with an antique lens or a pinhole camera.

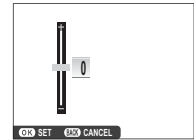

- ◆ To determine the amount required, adjust peripheral illumination correction while taking photos of blue sky or a sheet of gray paper.

## PhotoBook Assist

---

Create books from your favorite photos.

### ***Creating a PhotoBook***

**1** Select **NEW BOOK** for  **PHOTOBOOK ASSIST** in the playback menu ( 92):

- ❖ Neither photographs  or smaller nor movies can be selected for photobooks.
- ❖ The first picture selected becomes the cover image. Press the selector down to select a different image for the cover.

**2** Scroll through the images and press the selector up to select or deselect. To display the current image on the cover, press the selector down. Press **MENU/OK** to exit when the book is complete.

**3** Highlight **COMPLETE PHOTOBOOK** and press **MENU/OK** (to select all photos or all photos matching the specified search conditions for the book, choose **SELECT ALL**). The new book will be added to the list in the photo-book assist menu.

- ⓘ Books can contain up to 300 pictures.
- ⓘ Books that contain no photos are automatically deleted.

### **Viewing Photobooks**

Highlight a book in the photobook assist menu and press **MENU/OK** to display the book, then press the selector left or right to scroll through the pictures.

### **Editing and Deleting Photobooks**

Display the photobook and press **MENU/OK**. The following options will be displayed; select the desired option and follow the on-screen instructions.

- **EDIT:** Edit the book as described in “Creating a PhotoBook” (📖 78).
- **ERASE:** Delete the book.

#### **Photobooks**

Photobooks can be copied to a computer using the supplied MyFinePix Studio software (📖 107).

# Menus

## Using the Menus: Shooting Mode

The shooting menu is used to adjust settings for a wide range of shooting conditions. To display the shooting menu, press **MENU/OK** in shooting mode. Highlight items and press the selector right to view options, then highlight an option and press **MENU/OK**. Press **DISP/BACK** to exit when settings are complete.



### Shooting Menu Options (Photographs)

👉 The options available vary with the shooting mode selected.

#### 📷 SCENE POSITION

Choose a scene for **SP** mode (📖 45).





#### 📷 Adv. MODE

Choose an advanced shooting mode (📖 40).



**AF/MF SETTING**

Adjust focus settings.

Option	Description
<b>FOCUS AREA</b>	Choose the focus area (📖 55).
<b>FOCUS MODE</b>	Choose how the camera focuses (📖 52).
<b>AF+MF</b>	<p>This option takes effect when  <b>MULTI</b> or  <b>AREA</b> is selected for <b>AF/MF SETTING &gt; FOCUS MODE</b>. If <b>ON</b> is selected, focus can be adjusted manually by rotating the focus ring while the shutter button is pressed halfway. Focus peaking is supported (📖 85). Lenses with a focus distance indicator must be set to manual focus mode (MF) before this option can be used. Selecting MF disables the focus distance indicator. Set the focus ring to the center of the focus distance indicator, as the camera may fail to focus if the ring is set to infinity or the minimum focus distance.</p> <div data-bbox="277 415 1231 544" style="border: 1px solid gray; padding: 10px;"> <p> <b>AF + MF Focus Zoom</b></p> <p>When <b>ON</b> is selected for <b>SCREEN SET-UP &gt; FOCUS CHECK</b> in the setup menu and  <b>MULTI</b> or  <b>AREA</b> is selected for <b>AF/MF SETTING &gt; FOCUS MODE</b>, focus zoom can be used to zoom in on the selected focus area.</p> </div>

## AF/MF SETTING (Continued)

Option	Description												
<b>FACE/EYE DETECTION SETTING</b>	<p>Intelligent Face Detection sets focus and exposure for human faces anywhere in the frame, preventing the camera from focusing on the background in group portraits. Choose for shots that emphasize portrait subjects. Faces can be detected with the camera in vertical or horizontal orientation; if a face is detected, it will be indicated by a green border. If there is more than one face in the frame, the camera will select the face closest to the center; other faces are indicated by white borders. You can also choose whether the camera detects and focuses on eyes when Intelligent Face Detection is on. Choose from the following options:</p> 												
	<table border="1"> <thead> <tr> <th data-bbox="264 373 506 405">Option</th> <th data-bbox="506 373 1235 405">Description</th> </tr> </thead> <tbody> <tr> <td data-bbox="264 405 506 436"><b>FACE ON/EYE OFF</b></td> <td data-bbox="506 405 1235 436">Intelligent Face Detection only.</td> </tr> <tr> <td data-bbox="264 436 506 498"><b>FACE ON/EYE AUTO</b></td> <td data-bbox="506 436 1235 498">The camera automatically chooses which eye to focus on when a face is detected.</td> </tr> <tr> <td data-bbox="264 498 506 555"><b>FACE ON/RIGHT EYE PRIORITY</b></td> <td data-bbox="506 498 1235 555">The camera focuses on the right eye of subjects detected using Intelligent Face Detection.</td> </tr> <tr> <td data-bbox="264 555 506 612"><b>FACE ON/LEFT EYE PRIORITY</b></td> <td data-bbox="506 555 1235 612">The camera focuses on the left eye of subjects detected using Intelligent Face Detection.</td> </tr> <tr> <td data-bbox="264 612 506 647"><b>FACE OFF/EYE OFF</b></td> <td data-bbox="506 612 1235 647">Intelligent Face Detection and eye priority off.</td> </tr> </tbody> </table>	Option	Description	<b>FACE ON/EYE OFF</b>	Intelligent Face Detection only.	<b>FACE ON/EYE AUTO</b>	The camera automatically chooses which eye to focus on when a face is detected.	<b>FACE ON/RIGHT EYE PRIORITY</b>	The camera focuses on the right eye of subjects detected using Intelligent Face Detection.	<b>FACE ON/LEFT EYE PRIORITY</b>	The camera focuses on the left eye of subjects detected using Intelligent Face Detection.	<b>FACE OFF/EYE OFF</b>	Intelligent Face Detection and eye priority off.
	Option	Description											
	<b>FACE ON/EYE OFF</b>	Intelligent Face Detection only.											
	<b>FACE ON/EYE AUTO</b>	The camera automatically chooses which eye to focus on when a face is detected.											
	<b>FACE ON/RIGHT EYE PRIORITY</b>	The camera focuses on the right eye of subjects detected using Intelligent Face Detection.											
<b>FACE ON/LEFT EYE PRIORITY</b>	The camera focuses on the left eye of subjects detected using Intelligent Face Detection.												
<b>FACE OFF/EYE OFF</b>	Intelligent Face Detection and eye priority off.												
<p>◆ If the camera is unable to detect the subject's eyes because they are hidden by hair, glasses, or other objects, the camera will instead focus on faces.</p>													
<p>① In some modes, the camera may set exposure for the frame as a whole rather than the portrait subject.</p>													
<p>① If the subject moves as the shutter button is pressed, the face may not be in the area indicated by the green border when the picture is taken.</p>													

**AF/MF SETTING (Continued)**

Option	Description
<b>AF ILLUMINATOR</b>	If <b>ON</b> is selected, the AF-assist illuminator will light to assist autofocus.
	◆ The AF-assist illuminator turns off automatically when <b>OFF</b> is selected for <b>SOUND &amp; FLASH</b> in the setup menu.
	ⓘ The camera may be unable to focus using the AF-assist illuminator in some cases. If the camera is unable to focus in macro mode, try increasing the distance to the subject.
	ⓘ Avoid shining the AF-assist illuminator directly into your subject's eyes.

**ISO ISO**

Control the camera's sensitivity to light (67).

**IMAGE SIZE**

Choose the size and aspect ratio at which still pictures are recorded.

**Aspect Ratio**

Pictures with an aspect ratio of 3:2 have the same proportions as a frame of 35 mm film, while an aspect ratio of 16:9 is suited to display on High Definition (HD) devices. Pictures with an aspect ratio of 1:1 are square.

**IMAGE SIZE** is not reset when the camera is turned off or another shooting mode is selected.

Option	Prints at sizes up to	Option	Prints at sizes up to
<b>L 3:2</b>	41 × 28 cm (16 × 11 in.)	<b>S 3:2</b>	21 × 14 cm (8 × 5 in.)
<b>L 16:9</b>	41 × 23 cm (16 × 9 in.)	<b>S 16:9</b>	21 × 12 cm (8 × 4 in.)
<b>L 1:1</b>	28 × 28 cm (11 × 11 in.)	<b>S 1:1</b>	14 × 14 cm (5 × 5 in.)
<b>M 3:2</b>	29 × 20 cm (11 × 7 in.)		
<b>M 16:9</b>	29 × 16 cm (11 × 6 in.)		
<b>M 1:1</b>	20 × 20 cm (7 × 7 in.)		

**IMAGE QUALITY**

Choose a file format and compression ratio. Select **FINE** or **NORMAL** to record JPEG images, **RAW** to record RAW images, or **FINE+RAW** or **NORMAL+RAW** to record both JPEG and RAW images. **FINE** and **FINE+RAW** use lower JPEG compression ratios for higher-quality JPEG images, while **NORMAL** and **NORMAL+RAW** use higher JPEG compression ratios to increase the number of images that can be stored.

### DYNAMIC RANGE

Control contrast. Choose lower values to increase contrast when shooting indoors or under overcast skies, higher values to reduce loss of detail in highlights and shadows when photographing high-contrast scenes. Higher values are recommended for scenes that include both sunlight and deep shade, for such high-contrast subjects as sunlight on water, brightly-lit autumn leaves, and portraits taken against a blue sky, and for white objects or people wearing white; note, however, that mottling may appear in pictures taken at higher values.

- ◆ If **AUTO** is selected, the camera will automatically choose either **#100 100%** or **#200 200%** according to the subject and shooting conditions. Shutter speed and aperture will be displayed when the shutter button is pressed halfway.
- ◆ **#200 200%** is available at sensitivities of ISO 400 and above, **#400 400%** at sensitivities of ISO 800 and above.

### FILM SIMULATION

Simulate the effects of different types of film ( 73).

### FILM SIMULATION BKT

Choose film types for film simulation bracketing ( 62).

### SELF-TIMER

Take pictures with the self-timer ( 63).

### INTERVAL TIMER SHOOTING

Adjust settings for interval timer photography ( 65).

### WHITE BALANCE

Adjust colors to match the light source ( 58).

### COLOR

Adjust color density.

### SHARPNESS

Sharpen or soften outlines.

### HIGHLIGHT TONE

Adjust the appearance of highlights.

**SHADOW TONE**

Adjust the appearance of shadows.

**NR NOISE REDUCTION**

Reduce noise in pictures taken at high sensitivities.

**LONG EXPOSURE NR**

Select **ON** to reduce mottling in long time-exposures (📖 48, 50).

**CUSTOM SET**

Save settings for **P**, **S**, **A**, and **M** mode (📖 51).

**LENS MOUNT ADAPTOR SETTING**

Adjust settings for M-mount lenses connected using an optional **FUJIFILM M MOUNT ADAPTER** (📖 76).

**SHOOT WITHOUT LENS**

Choose whether shutter release is enabled when no lens is attached.

**MF ASSIST**

Choose how focus is displayed in manual focus mode (📖 53).

Option	Description
<b>STANDARD</b>	Focus is displayed normally (focus peaking is not available).
<b>FOCUS PEAK HIGHLIGHT</b>	The camera heightens high-contrast outlines. Choose a color and peaking level.

**PHOTOMETRY**

Choose how the camera meters exposure when Intelligent Face Detection is off (📖 70).

**INTERLOCK SPOT AE & FOCUS AREA**

Select **ON** to meter the current focus frame when **AREA** is selected for **AF AF/MF SETTING > FOCUS MODE** and **SPOT** is selected for **PHOTOMETRY**.

**FLASH SET-UP**

Adjust flash settings.







Option	Description
<b>FLASH MODE</b>	Choose a flash mode (71).
<b>FLASH COMPENSATION</b>	Adjust flash brightness. Choose from values between +2 EV and -2 EV. Note that the desired results may not be achieved depending on shooting conditions and the distance to the subject.
<b>RED EYE REMOVAL</b>	Choose <b>ON</b> to remove red-eye effects caused by the flash. <ul style="list-style-type: none"> <li>◆ Red-eye reduction is performed only when a face is detected.</li> <li>◆ Red-eye removal is not available with RAW images.</li> </ul>

**MOVIE SET-UP**

Adjust movie settings.





Option	Description
<b>MOVIE MODE</b>	Select a frame size and rate for movie recording. <ul style="list-style-type: none"> <li style="width: 50%;">• <b>HD 1080/30 P</b>: Full HD (30 fps)</li> <li style="width: 50%;">• <b>HD 720/60 P</b>: HD (60 fps)</li> <li style="width: 50%;">• <b>HD 1080/25 P</b>: Full HD (25 fps)</li> <li style="width: 50%;">• <b>HD 720/50 P</b>: HD (50 fps)</li> <li style="width: 50%;">• <b>HD 1080/24 P</b>: Full HD (24 fps)</li> <li style="width: 50%;">• <b>HD 720/24 P</b>: HD (24 fps)</li> </ul>
<b>MOVIE ISO</b>	Choose the sensitivity for movie recording from <b>AUTO</b> or from settings between ISO 400 and 6400. <ul style="list-style-type: none"> <li>◆ This setting has no effect on photographs.</li> </ul>

 **MOVIE SET-UP (Continued)**

Option	Description
<b>FOCUS MODE</b>	<p>This option controls how the camera focuses during movie recording.</p> <ul style="list-style-type: none"> <li>•  <b>CENTER</b>: When shooting starts, the camera focuses on the subject in the center of the frame.</li> <li>•  <b>CONTINUOUS</b>: The camera continuously adjusts focus to reflect changes in the distance to subjects near the center of the frame.</li> <li>•  <b>MANUAL</b>: Focus manually.</li> </ul> <p>◆ Note that in  mode, the camera focuses continuously, increasing the drain on the battery, and that the sound of the camera focusing may be audible.</p> <p>◆ If a face is detected when  is selected, a  icon will be displayed and the camera will continuously adjust focus to maintain focus on the face.</p>
<b>MIC LEVEL ADJUSTMENT</b>	Adjust the microphone recording level.

 **IS MODE**

Choose from the following image stabilization options:

Option	Description
 <b>CONTINUOUS + MOTION</b>	Image stabilization on. If <b>+ MOTION</b> is selected, the camera will adjust shutter speed to reduce motion blur when a moving objects are detected.
 <b>CONTINUOUS</b>	
 <b>SHOOTING + MOTION</b>	As above, except that image stabilization is performed only when the shutter button is pressed halfway or the shutter is released. If <b>+ MOTION</b> is selected, the camera will adjust shutter speed to reduce motion blur when a moving objects are detected.
 <b>SHOOTING ONLY</b>	
<b>OFF</b>	Image stabilization off. Choose this option when using a tripod.

- ◆ **+ MOTION** has no effect when sensitivity is set to a fixed value, and may also be unavailable at some other combinations of settings. The effect may vary with lighting conditions and the speed at which the object is moving.
- ◆ IS mode is available only when lens that supports image stabilization is attached.

### DIGITAL IMAGE STABILIZER

Choose whether to enable digital image stabilization during movie recording.

### WIRELESS COMMUNICATION

Connect to a smartphone or tablet over a wireless network ( 106).

◆ For more information, visit <http://fujifilm-dsc.com/wifi/>.

### SHUTTER TYPE

Choose the shutter type. Choose the electronic shutter to mute the shutter sound.

Option	Description
<b>MS MECHANICAL SHUTTER</b>	Take pictures with the mechanical shutter.
<b>ES ELECTRONIC SHUTTER</b>	Take pictures with the electronic shutter.
<b>MS MECHANICAL + ES ELECTRONIC</b>	The camera chooses the shutter type according to shooting conditions.

◆ When the electronic shutter is used, the flash is disabled, shutter speed and sensitivity are restricted to values of  $\frac{1}{32,000}$ –1 s and ISO 6400–200 respectively, and long exposure noise reduction has no effect. In burst mode, focus and exposure are fixed at the values for the first shot in each burst.

ⓘ Distortion may be visible in shots of moving subjects with electronic shutter, while banding and fog may occur in shots taken under fluorescent lights or other flickering or erratic illumination. When taking pictures with the shutter muted, respect your subjects' image rights and right to privacy.



## Using the Menus: Playback Mode

To display the playback menu, press **MENU/OK** in playback mode. Highlight items and press the selector right to view options, then highlight an option and press **MENU/OK**. Press **DISP/BACK** to exit when settings are complete.

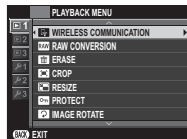

### Playback Menu Options

#### WIRELESS COMMUNICATION

Connect to a smartphone or tablet over a wireless network (📄 106).

🔍 For more information, visit <http://fujifilm-dsc.com/wifi/>.

#### RAW CONVERSION

Create JPEG copies of RAW pictures (📄 75).

#### ERASE

Delete all or selected pictures.

- **FRAME:** Press the selector left or right to scroll through pictures and press **MENU/OK** to delete the current picture (a confirmation dialog is not displayed).
- **SELECTED FRAMES:** Highlight pictures and press **MENU/OK** to select or deselect. When the operation is complete, press **DISP/BACK** to display a confirmation dialog, then highlight **OK** and press **MENU/OK**.
- **ALL FRAMES:** A confirmation dialog will be displayed; highlight **OK** and press **MENU/OK** to delete all unprotected pictures.

## CROP

Create a cropped copy of the current picture.

- 1 Display the desired picture.
  - 2 Select  **CROP** in the playback menu.
  - 3 Use the sub-command dial to zoom in and out and press the selector up, down, left, or right to scroll the picture until the desired portion is displayed.
  - 4 Press **MENU/OK** to display a confirmation dialog.
  - 5 Press **MENU/OK** again to save the cropped copy to a separate file.
- ◆ Larger crops produce larger copies; all copies have an aspect ratio of 3:2. If the size of the final copy will be **640**, **OK** will be displayed in yellow.

## RESIZE

Create a small copy of the current picture.

- 1 Display the desired picture.
  - 2 Select  **RESIZE** in the playback menu.
  - 3 Highlight a size and press **MENU/OK** to display a confirmation dialog.
  - 4 Press **MENU/OK** again to save the resized copy to a separate file.
- ◆ The sizes available vary with the size of the original image.
-

**PROTECT**

Protect pictures from accidental deletion. Highlight one of the following options and press **MENU/OK**.

- **FRAME**: Protect selected pictures. Press the selector left or right to view pictures and press **MENU/OK** to select or deselect. Press **DISP/BACK** when the operation is complete.
  - **SET ALL**: Protect all pictures.
  - **RESET ALL**: Remove protection from all pictures.
- ① Protected pictures will be deleted when the memory card is formatted (🗨 102).

**IMAGE ROTATE**

Rotate pictures.

- 1 Display the desired picture.
  - 2 Select **IMAGE ROTATE** in the playback menu.
  - 3 Press the selector down to rotate the picture 90° clockwise, up to rotate it 90° counterclockwise.
  - 4 Press **MENU/OK**. The picture automatically be displayed in the selected orientation whenever it is played back on the camera.
- ❖ Protected pictures can not be rotated. Remove protection before rotating pictures.
  - ❖ The camera may not be able to rotate pictures created with other devices. Pictures rotated on the camera will not be rotated when viewed on a computer or on other cameras.
  - ❖ Pictures taken with **SCREEN SET-UP > AUTOROTATE PB** are automatically displayed in the correct orientation during playback (🗨 97).



### RED EYE REMOVAL

Remove red-eye from portraits. The camera will analyze the image; if red-eye is detected, the image will be processed to create a copy with reduced red-eye.

**1** Display the desired picture.

**2** Select  **RED EYE REMOVAL** in the playback menu.

**3** Press **MENU/OK**.

- ◆ Red eye may not be removed if the camera is unable to detect a face or the face is in profile. Results may differ depending on the scene. Red eye can not be removed from pictures that have already been processed using red-eye removal or pictures created with other devices.
- ◆ The amount of time needed to process the image varies with the number of faces detected.
- ◆ Copies created with  **RED EYE REMOVAL** are indicated by a  icon during playback.
- ◆ Red eye removal can not be performed on RAW images.

### SLIDE SHOW

View pictures in an automated slide show. Press **MENU/OK** to start and press the selector right or left to skip ahead or back. Press **DISP/BACK** at any time during the show to view on-screen help. The show can be ended at any time by pressing **MENU/OK**.

- ◆ The camera will not turn off automatically while a slide show is in progress.

### PHOTOBOOK ASSIST

Create books from your favorite photos ( 78).

---

**PC AUTO SAVE**

Upload pictures to a computer over a wireless network (📖 106).

◆ For more information, visit <http://fujifilm-dsc.com/wifi/>.

**PRINT ORDER (DPOF)**

Create a digital “print order” for DPOF-compatible printers (📖 110).

**instax PRINTER PRINT**

Print pictures on optional FUJIFILM instax SHARE printers (📖 112).

**DISP ASPECT**

Choose how **H**igh **D**efinition (HD) devices display pictures with an aspect ratio of 3:2 (this option is available only when an HDMI cable is connected). Select 16:9 to display the image so that it fills the screen with its top and bottom cropped out, 3:2 to display the entire image with black bands at either side.

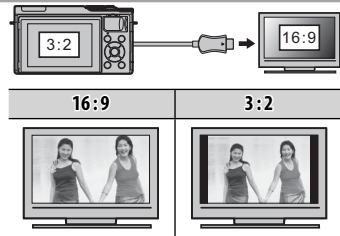

# The Setup Menu

## Using the Setup Menu

### 1 Display the setup menu.

1.1 Press **MENU/OK** to display the menu for the current mode.

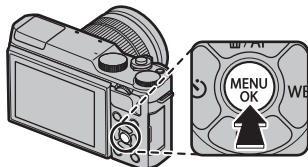

1.2 Press the selector left to highlight the tab for the current menu.



1.3 Press the selector down to highlight the tab containing the desired option.

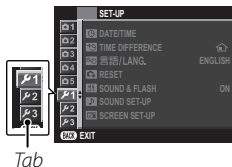

1.4 Press the selector right to place the cursor in the setup menu.



### 2 Adjust settings.

Highlight items and press the selector right to view options, then highlight an option and press **MENU/OK**. Press **DISP/BACK** to exit when settings are complete.

## Setup Menu Options





### DATE/TIME

Set the camera clock ( 22).

### TIME DIFFERENCE

Switch the camera clock instantly from your home time zone to the local time at your destination when traveling. To specify the difference between local time and your home time zone:

- 1 Highlight  **LOCAL** and press **MENU/OK**.
- 2 Use the selector to choose the time difference between local time and your home time zone. Press **MENU/OK** when settings are complete.

To set the camera clock to local time, highlight  **LOCAL** and press **MENU/OK**. To set the clock to the time in your home time zone, select  **HOME**. If  **LOCAL** is selected,  will be displayed for three seconds when the camera is turned on.

### 言語/LANG.

Choose a language ( 22).

### RESET

Reset shooting or setup menu options to default values. Custom white balance, custom settings banks created using  **CUSTOM SET**,  **WIRELESS SETTINGS**, and the setup menu  **DATE/TIME**,  **TIME DIFFERENCE** options are not affected.

- 1 Highlight the desired option and press the selector right.
- 2 A confirmation dialog will be displayed; highlight **OK** and press **MENU/OK**.

### SOUND & FLASH

Select **OFF** to disable the speaker, flash, and illuminator in situations in which camera sounds or lights may be unwelcome.  appears in the display when **OFF** is selected.

**SOUND SET-UP**

Adjust sound settings.















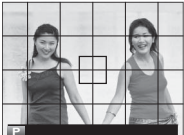

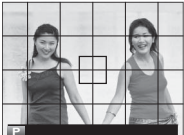

Option	Description
<b>OPERATION VOL.</b>	Adjust the volume of the sounds produced when camera controls are operated. Choose <b>OFF</b> (mute) to disable control sounds.
<b>SHUTTER VOLUME</b>	Adjust the volume of the sounds produced when the electronic shutter. Choose <b>OFF</b> (mute) to disable the shutter sound.
<b>SHUTTER SOUND</b>	Choose the sound made by the electronic shutter.
<b>PLAYBACK VOLUME</b>	Adjust the volume for movie playback.

**SCREEN SET-UP**

Adjust display settings.

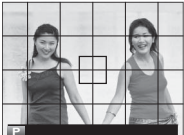

Option	Description									
<b>IMAGE DISP.</b>	Choose how long images are displayed after shooting. Colors may differ slightly from those in the final image and "noise" mottling may be visible at high sensitivities. Note that at some settings, the camera will display pictures after shooting regardless of the option selected.									
	<table border="1"> <thead> <tr> <th>Option</th> <th>Description</th> </tr> </thead> <tbody> <tr> <td><b>CONTINUOUS</b></td> <td>Pictures are displayed until the <b>MENU/OK</b> button is pressed or the shutter button is pressed halfway. To zoom in on the active focus point, press the center of the sub-command dial; press again to cancel zoom.</td> </tr> <tr> <td><b>1.5 SEC</b></td> <td rowspan="2">Pictures are displayed for 1.5 seconds (<b>1.5 SEC</b>) or 0.5 seconds (<b>0.5 SEC</b>) or until the shutter button is pressed halfway.</td> </tr> <tr> <td><b>0.5 SEC</b></td> </tr> <tr> <td><b>OFF</b></td> <td>Pictures are not displayed after shooting.</td> </tr> </tbody> </table>	Option	Description	<b>CONTINUOUS</b>	Pictures are displayed until the <b>MENU/OK</b> button is pressed or the shutter button is pressed halfway. To zoom in on the active focus point, press the center of the sub-command dial; press again to cancel zoom.	<b>1.5 SEC</b>	Pictures are displayed for 1.5 seconds ( <b>1.5 SEC</b> ) or 0.5 seconds ( <b>0.5 SEC</b> ) or until the shutter button is pressed halfway.	<b>0.5 SEC</b>	<b>OFF</b>	Pictures are not displayed after shooting.
	Option	Description								
	<b>CONTINUOUS</b>	Pictures are displayed until the <b>MENU/OK</b> button is pressed or the shutter button is pressed halfway. To zoom in on the active focus point, press the center of the sub-command dial; press again to cancel zoom.								
<b>1.5 SEC</b>	Pictures are displayed for 1.5 seconds ( <b>1.5 SEC</b> ) or 0.5 seconds ( <b>0.5 SEC</b> ) or until the shutter button is pressed halfway.									
<b>0.5 SEC</b>										
<b>OFF</b>	Pictures are not displayed after shooting.									
<b>PREVIEW EXP. IN MANUAL MODE</b>	Select <b>ON</b> to enable exposure preview in manual exposure mode. Select <b>OFF</b> when using the flash or on other occasions on which exposure may change when the picture is taken.									



☑ SCREEN SET-UP (Continued)							
Option	Description						
<b>LCD BRIGHTNESS</b>	Adjust monitor brightness.						
<b>LCD COLOR</b>	Adjust monitor hue.						
<b>PREVIEW PIC. EFFECT</b>	<p>Choose <b>ON</b> to preview the effects of film simulation, white balance, and other settings in the monitor. Choose <b>OFF</b> to make shadows in low-contrast, back-lit scenes and other hard-to-see subjects more visible.</p> <p>◆ If <b>OFF</b> is selected, the effects of camera settings will not be visible in the monitor and colors and tone will differ from those in the final picture. The display will however be adjusted to show the effects of advanced filters and of monochrome and sepia settings.</p>						
<b>FRAMING GUIDELINE</b>	<p>Choose the type of framing grid available in shooting mode.</p> <table border="1" style="width: 100%; text-align: center;"> <thead> <tr> <th> <b>GRID 9</b></th> <th> <b>GRID 24</b></th> <th> <b>HD FRAMING</b></th> </tr> </thead> <tbody> <tr> <td>  <p><i>For "rule of thirds" composition.</i></p> </td> <td>  <p><i>A six-by-four grid.</i></p> </td> <td>  <p><i>Frame HD pictures in the crop shown by the lines at the top and bottom of the display.</i></p> </td> </tr> </tbody> </table>	 <b>GRID 9</b>	 <b>GRID 24</b>	 <b>HD FRAMING</b>	 <p><i>For "rule of thirds" composition.</i></p>	 <p><i>A six-by-four grid.</i></p>	 <p><i>Frame HD pictures in the crop shown by the lines at the top and bottom of the display.</i></p>
 <b>GRID 9</b>	 <b>GRID 24</b>	 <b>HD FRAMING</b>					
 <p><i>For "rule of thirds" composition.</i></p>	 <p><i>A six-by-four grid.</i></p>	 <p><i>Frame HD pictures in the crop shown by the lines at the top and bottom of the display.</i></p>					
<b>AUTOROTATE PB</b>	Choose <b>ON</b> to automatically rotate "tall" (portrait-orientation) pictures during playback.						
<b>FOCUS CHECK</b>	If <b>ON</b> is selected, the camera will automatically zoom in on the view through the lens when the focus ring is rotated in manual focus mode (📖 54).						
<b>FOCUS SCALE UNITS</b>	Choose the units used for the focus distance indicator (📖 53).						
<b>DISP. CUSTOM SETTING</b>	Choose items for the standard display (📖 25).						

### **BUTTON SETTING**

Choose the roles played by camera controls.

Option	Description
<b>FUNCTION (Fn) SETTING</b>	Choose the roles played by the function buttons (  37).
<b>EDIT/SAVE QUICK MENU</b>	Choose the options displayed in the quick menu (  36).

### **FOCUS RING**

Choose the direction in which the focus ring is rotated to increase the focus distance.



### **POWER MANAGEMENT**

Adjust power management settings.

Option	Description
<b>AUTO POWER OFF</b>	Choose the length of time before the camera turns off automatically when no operations are performed. Shorter times increase battery life; if <b>OFF</b> is selected, the camera must be turned off manually. Note that in some situations the camera turns off automatically even when <b>OFF</b> is selected.
<b>HIGH PERFORMANCE</b>	Select <b>ON</b> for faster focus and to reduce the time needed to restart the camera after it has been turned off.

### **SENSOR CLEANING**

Remove dust from the camera image sensor.



- **OK:** Clean sensor immediately ( xi).
- **WHEN SWITCHED ON:** If this option is selected, sensor cleaning will be performed when the camera turns on.
- **WHEN SWITCHED OFF:** If this option is selected, sensor cleaning will be performed when the camera turns off (sensor cleaning is not however performed if the camera turns off in playback mode).
- ◆ Dust that can not be removed using sensor cleaning can be removed manually ( 119).

## SAVE DATA SET-UP

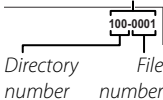
Adjust file management settings.

Option	Description						
<b>FRAME NO.</b>	<p>New pictures are stored in image files named using a four-digit file number assigned by adding one to the last file number used. The file number is displayed during playback as shown at right. <b>FRAME NO.</b> controls whether file numbering is reset to 0001 when a new memory card is inserted or the current memory card is formatted.</p> <div style="text-align: right;">  </div>						
	<table border="1"> <thead> <tr> <th data-bbox="225 339 339 370">Option</th> <th data-bbox="339 339 1233 370">Description</th> </tr> </thead> <tbody> <tr> <td data-bbox="225 370 339 430"><b>CONTINUOUS</b></td> <td data-bbox="339 370 1233 430">Numbering continues from the last file number used or the first available file number, whichever is higher. Choose this option to reduce the number of pictures with duplicate file names.</td> </tr> <tr> <td data-bbox="225 430 339 462"><b>RENEW</b></td> <td data-bbox="339 430 1233 462">Numbering is reset to 0001 after formatting or when a new memory card is inserted.</td> </tr> </tbody> </table>	Option	Description	<b>CONTINUOUS</b>	Numbering continues from the last file number used or the first available file number, whichever is higher. Choose this option to reduce the number of pictures with duplicate file names.	<b>RENEW</b>	Numbering is reset to 0001 after formatting or when a new memory card is inserted.
	Option	Description					
	<b>CONTINUOUS</b>	Numbering continues from the last file number used or the first available file number, whichever is higher. Choose this option to reduce the number of pictures with duplicate file names.					
<b>RENEW</b>	Numbering is reset to 0001 after formatting or when a new memory card is inserted.						
<ul style="list-style-type: none"> <li>◆ If the frame number reaches 999-9999, the shutter release will be disabled (📖 127).</li> <li>◆ Selecting <b>RESET</b> (🗨 95) sets <b>FRAME NO.</b> to <b>CONTINUOUS</b> but does not reset the file number.</li> <li>◆ Frame numbers for pictures taken with other cameras may differ.</li> </ul>							
<b>SAVE ORG IMAGE</b>	Choose <b>ON</b> to save unprocessed copies of pictures taken using <b>RED EYE REMOVAL</b> .						
<b>EDIT FILE NAME</b>	Change the file name prefix. sRGB images use a four-letter prefix (default "DSCF"), Adobe RGB images a three-letter prefix ("DSF") preceded by an underscore.						

 **SAVE DATA SET-UP (Continued)**

Option	Description
<b>DATE STAMP</b>	<p>Stamp the time and/or date of recording on photographs as they are taken.</p> <ul style="list-style-type: none"> <li>• +: Stamp new photographs with the date and time of recording.</li> <li>• : Stamp new photographs with the date of recording.</li> <li>• <b>OFF</b>: Do not stamp the time and date on new photographs.</li> </ul> <p>ⓘ Time and date stamps can not be deleted. Turn <b>DATE STAMP</b> off to prevent time and date stamps appearing on new photographs.</p> <p>ⓘ If the camera clock is not set, you will be prompted to set the clock to the current date and time (📖 22).</p> <p>ⓘ We recommend that you turn the DPOF “print date” option off when printing images with a time and date stamp (📖 110).</p> <p>ⓘ Time and date stamps do not appear on movies and RAW images.</p>

 **COLOR SPACE**

Choose the gamut of colors available for color reproduction.



Option	Description
<b>sRGB</b>	Recommended in most situations.
<b>Adobe RGB</b>	For commercial printing.

 **CUSTOM RESET**

Reset all settings for mode **C**. A confirmation dialog will be displayed, press the selector up or down to highlight **OK** and press **MENU/OK**.

 **CONNECTION SETTING**

Adjust settings for connection to wireless devices, including smartphones, computers, and FUJIFILM instax SHARE printers.

Option	Description	
<b>WIRELESS SETTINGS</b>	Adjust settings for connection to wireless networks.	
	Option	Description
	<b>GENERAL SETTINGS</b>	Choose a name ( <b>NAME</b> ) to identify the camera on the wireless network (the camera is assigned a unique name by default) or select <b>RESET WIRELESS SETTINGS</b> to restore default settings.
	<b>RESIZE IMAGE FOR SMARTPHONE </b>	Choose <b>ON</b> (the default setting, recommended in most circumstances) to resize larger images to <b>3M</b> for upload to smartphones, <b>OFF</b> to upload images at their original size. Resizing applies only to the copy uploaded to the smartphone; the original is not affected.
<b>PC AUTO SAVE SETTING</b>	Choose an upload destination. Choose <b>SIMPLE SETUP</b> to connect using WPS, <b>MANUAL SETUP</b> to configure network settings manually.	
<b>GEOTAGGING SET-UP</b>	View location data downloaded from a smartphone and choose whether to save the data with your pictures.	
	Option	Description
	<b>GEOTAGGING</b>	Choose whether location data downloaded from a smartphone are embedded in pictures as they are taken.
<b>LOCATION INFO</b>	Display the location data last downloaded from a smartphone.	
<b>instax PRINTER CONNECTION SETTING</b>	Adjust settings for connection to optional FUJIFILM instax SHARE printers (  112).	

 For more information on wireless connections, visit <http://fujifilm-dsc.com/wifi/>.



### **FORMAT**

To format the memory card:

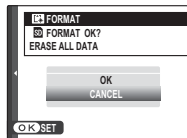











- 1 Highlight  **FORMAT** in the setup menu and press **MENU/OK**.
  - 2 A confirmation dialog will be displayed. To format the memory card, highlight **OK** and press **MENU/OK**.  
To exit without formatting the memory card, select **CANCEL** or press **DISP/BACK**.
- ⓘ All data—including protected pictures—will be deleted from the memory card. Be sure important files have been copied to a computer or other storage device.
- ⓘ Do not open the battery-chamber cover during formatting.























## Factory Defaults







The factory default settings for the options in the shooting and setup menus are listed below. These settings can be restored using the  **RESET** option in the setup menu ( 95).

### Shooting Menu

Menu	Default
 SCENE POSITION	 PORTRAIT
 Adv. MODE	 ADVANCED FILTER
 AF/MF SETTING	
FOCUS MODE	 AREA
AF+MF	OFF
FACE/EYE DETECTION SETTING	FACE OFF/EYE OFF
AF ILLUMINATOR	ON
 ISO	200
 IMAGE SIZE	 3:2
 IMAGE QUALITY	FINE
 DYNAMIC RANGE	 100%

Menu	Default
 FILM SIMULATION	 PROVIA/STANDARD
 FILM SIMULATION BKT	
FILM 1	 PROVIA/STANDARD
FILM 2	 Velvia/VIVID
FILM 3	 ASTIA/SOFT
 SELF-TIMER	OFF
 WHITE BALANCE	AUTO
 COLOR	(0) MID
 SHARPNESS	(0) STANDARD
 HIGHLIGHT TONE	(0) STANDARD
 SHADOW TONE	(0) STANDARD
 NOISE REDUCTION	(0) STANDARD
 LONG EXPOSURE NR	ON

Menu	Default
 MOUNT ADAPTOR SETTING	LENS 5 (50mm)
 SHOOT WITHOUT LENS	OFF
 MF ASSIST	STANDARD
 PHOTOMETRY	 MULTI
 INTERLOCK SPOT AE & FOCUS AREA	ON
 FLASH SET-UP	
FLASH MODE	AUTO
FLASH COMPENSATION	±0
RED EYE REMOVAL	OFF

Menu	Default
 MOVIE SET-UP	
MOVIE MODE	 1080/30P
MOVIE ISO	AUTO
FOCUS MODE	 CONTINUOUS
MIC LEVEL ADJUSTMENT	3
 IS MODE	 CONTINUOUS + MOTION
 DIGITAL IMAGE STABILIZER	ON
 SHUTTER TYPE	MS MECHANICAL SHUTTER



## ■ Setup Menu

Menu	Default
SOUND & FLASH	ON
SOUND SET-UP	
OPERATION VOL.	1
SHUTTER VOLUME	1
SHUTTER SOUND	♪ 1 SOUND 1
PLAYBACK VOLUME	7
SCREEN SET-UP	
IMAGE DISP.	OFF
PREVIEW EXP. IN MANUAL MODE	ON
LCD BRIGHTNESS	0
LCD COLOR	0
PREVIEW PIC. EFFECT	ON
FRAMING GUIDELINE	GRID 9
AUTOROTATE PB	ON
FOCUS CHECK	OFF
FOCUS SCALE UNITS	METERS
DISP. CUSTOM SETTING	<ul style="list-style-type: none"> <li>• FRAMING GUIDELINE: <input type="checkbox"/></li> <li>• AF DISTANCE INDICATOR: <input type="checkbox"/></li> <li>• HISTOGRAM: <input type="checkbox"/></li> <li>• All other options: <input checked="" type="checkbox"/></li> </ul>

Menu	Default
BUTTON SETTING	
FUNCTION (Fn) SETTING	ISO
EDIT/SAVE QUICK MENU	See page 35.
FOCUS RING	CW
POWER MANAGEMENT	
AUTO POWER OFF	2 MIN
HIGH PERFORMANCE	OFF
SENSOR CLEANING	
WHEN SWITCHED ON	OFF
WHEN SWITCHED OFF	ON
SAVE DATA SET-UP	
FRAME NO.	CONTINUOUS
SAVE ORG IMAGE	OFF
DATE STAMP	OFF
COLOR SPACE	sRGB
CONNECTION SETTING	
WIRELESS SETTINGS	
GEOTAGGING SET-UP	<ul style="list-style-type: none"> <li>• RESIZE IMAGE FOR SMARTPHONE : ON</li> <li>• GEOTAGGING: ON</li> <li>• LOCATION INFO: ON</li> </ul>

## Connections

### Wireless Transfer (FUJIFILM Camera Remote/FUJIFILM PC AutoSave)

Access wireless networks and connect to computers, smartphones, or tablets. For downloads and other information, visit <http://fujifilm-dsc.com/wifi/>.



fujifilm Wi-Fi app



#### Wireless Connections: Smartphones

Install the “FUJIFILM Camera Remote” app on your smartphone to browse the images on the camera, download selected images, control the camera remotely, or copy location data to the camera. To connect to the smartphone, press the camera function button (**Fn**).

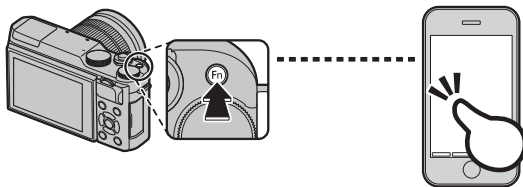

- ◆ You can also connect using the **WIRELESS COMMUNICATION** options in the camera shooting and playback menu.

#### Wireless Connections: Computers

Once you have installed the “FUJIFILM PC AutoSave” application and configured your computer as a destination for the images copied from the camera, you can upload pictures from the camera using the **PC AUTO SAVE** option in the camera playback menu or by pressing and holding the function button (**Fn**) in playback mode.

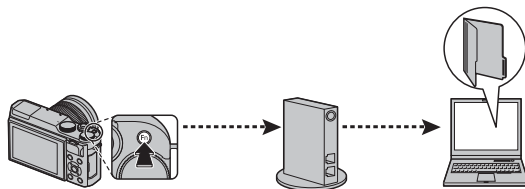

## Viewing Pictures on a Computer (MyFinePix Studio/RAW FILE CONVERTER)

Read this section for information on copying pictures to a computer.

### **Windows**

Use MyFinePix Studio to copy pictures to your computer, where they can be stored, viewed, organized, and printed. MyFinePix Studio is available for download from the following website:

<http://fujifilm-dsc.com/mfs/>



Once download is complete, double-click the downloaded file ("MFPS\_Setup.EXE") and follow the on-screen instructions to complete installation.

### **Macintosh**

Pictures can be copied to your computer using Image Capture (supplied with your computer) or other software.

#### **Viewing RAW Files**

To view RAW files on your computer, use the RAW FILE CONVERTER, available for download from:

<http://fujifilm-dsc.com/rfc/>



## **Connecting the Camera**

**1** Find a memory card containing pictures you want to copy to the computer and insert the card into the camera.

Ⓢ Loss of power during transfer could result in loss of data or damage to the memory card. Insert a fresh or fully-charged battery before connecting the camera.

**2** Turn the camera off and connect the supplied USB cable as shown, making sure the connectors are fully inserted. Connect the camera directly to the computer; do not use a USB hub or keyboard.

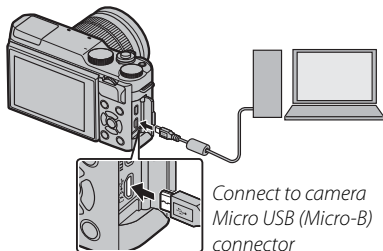

Ⓢ The camera uses a Micro-B USB 2.0 connector.

**3** Turn the camera on.

**4** Copy pictures to the computer using MyFinePix Studio or applications provided with your operating system.

For more information on using the software, start the application and select the appropriate option from the **Help** menu.

- ❗ If a memory card containing a large number of images is inserted, there may be a delay before the software starts and you may be unable to import or save images. Use a memory card reader to transfer pictures.
- ❗ Make sure that the computer does not display a message stating that copying is in progress and that the indicator lamp is out before turning the camera off or disconnecting the USB cable (if the number of images copied is very large, the indicator lamp may remain lit after the message has cleared from the computer display). Failure to observe this precaution could result in loss of data or damage to the memory card.
- ❗ Disconnect the camera before inserting or removing memory cards.
- ❗ In some cases, it may not be possible to access pictures saved to a network server using the software in the same way as on a standalone computer.
- ❗ The user bears all applicable fees charged by the phone company or Internet service provider when using services that require an Internet connection.

#### **Disconnecting the Camera**

After confirming that the indicator lamp is out, turn the camera off and disconnect the USB cable.

## Creating a DPOF Print Order

The **PRINT ORDER (DPOF)** option in the playback menu can be used to create a digital “print order” for DPOF-compatible printers.

### DPOF

DPOF (**D**igital **P**rint **O**rders **F**ormat) is standard that allows pictures to be printed from “print orders” stored on the memory card. The information in the order includes the pictures to be printed and the number of copies of each picture.



### WITH DATE /WITHOUT DATE

To modify the DPOF print order, select **PRINT ORDER (DPOF)** in the playback menu and press the selector up or down to highlight **WITH DATE ** or **WITHOUT DATE**.

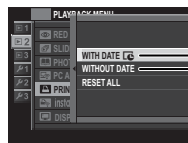

**WITH DATE **: Print date of recording on pictures.

**WITHOUT DATE**: Print pictures without date.

Press **MENU/OK** and follow the steps below.

- 1 Press the selector left or right to display a picture you wish to include in or remove from the print order.

- 2 Press the selector up or down to choose the number of copies (up to 99). To remove a picture from the order, press the selector down until the number of copies is 0.

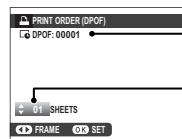

Total number of prints

Number of copies

- 3 Repeat steps 1–2 to complete the print order. Press **MENU/OK** to save the print order when settings are complete, or **DISP/BACK** to exit without changing the print order.

4 The total number of prints is displayed in the monitor. Press **MENU/OK** to exit.

The pictures in the current print order are indicated by a  icon during playback.

## ■ RESET ALL

To cancel the current print order, select **RESET ALL** for  **PRINT ORDER (DPOF)**. The confirmation shown at right will be displayed; press **MENU/OK** to remove all pictures from the order.

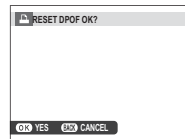

- ◆ Print orders can contain a maximum of 999 pictures.
- ◆ If a memory card is inserted containing a print order created by another camera, the message shown at right will be displayed. Pressing **MENU/OK** cancels the print order; a new print order must be created as described above.

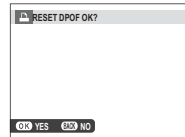

## instax SHARE Printers

Print pictures from your digital camera to instax SHARE printers.

### ***Establishing a Connection***

Select  **CONNECTION SETTING** > **instax PRINTER CONNECTION SETTING** in the camera setup menu and enter the instax SHARE printer name (SSID) and password.

#### **The Printer Name (SSID) and Password**

The printer name (SSID) can be found on the bottom of the printer; the default password is "1111". If you have already chosen a different password to print from a smartphone, enter that password instead.

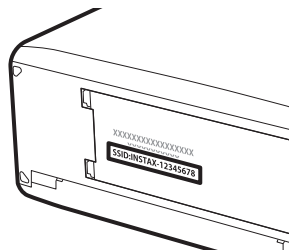



## Printing Pictures

1 Turn the printer on.

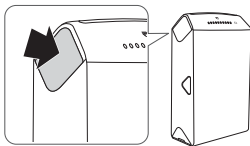

2 Select **instax PRINTER PRINT** in the camera playback menu. The camera will connect to the printer.

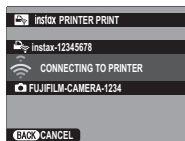

◆ To print a frame from a burst sequence, display the frame before selecting **instax PRINTER PRINT**.

3 Use the selector to display the picture you want to print, then press **MENU/OK**.

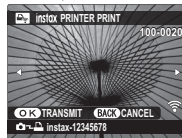

- ◆ Pictures taken with other cameras can not be printed.
- ◆ The area printed is smaller than the area visible in the LCD monitor.

4 The picture will be sent to the printer and printing will start.



## Viewing Pictures on TV

To show pictures to a group, connect the camera to a TV using an HDMI cable (available separately from third-party suppliers; note that the TV can only be used for playback, not shooting).

- 1 Turn the camera off.
- 2 Connect the cable as shown below, making sure the connectors are fully inserted in the correct orientation.

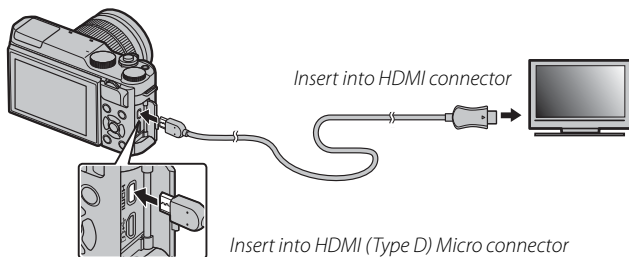

- ① Use an HDMI cable no more than 1.5 m (4.9 ft.) long with a type D (HDMI Micro) connector for connection to the camera.
  - ◆ Be sure the connectors are fully inserted.
- 3 Tune the television to the HDMI input channel. See the documentation supplied with the television for details.
- 4 Turn the camera on and press  button. The camera monitor turns off and pictures and movies are played back on the TV. Note that the camera volume controls have no effect on sounds played on the TV; use the television volume controls to adjust the volume.
  - ◆ The USB cable can not be used while an HDMI cable is connected.
  - ◆ Some televisions may briefly display a black screen when movie playback begins.

# Technical Notes

## Optional Accessories

The camera supports a wide range of accessories from FUJIFILM and other manufacturers.

### **Accessories from FUJIFILM**

The following optional accessories are available from FUJIFILM. For the latest information on the accessories available in your region, check with your local FUJIFILM representative or visit [http://www.fujifilm.com/products/digital\\_cameras/index.html](http://www.fujifilm.com/products/digital_cameras/index.html).

#### **Rechargeable Li-ion batteries**

**NP-W126/NP-W126S:** Additional large-capacity NP-W126/NP-W126S rechargeable batteries can be purchased as required.



#### **Battery chargers**

**BC-W126:** Replacement battery chargers can be purchased as required. At +20°C/+68°F, the BC-W126 charges an NP-W126/NP-W126S in about 150 minutes.

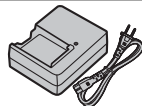

#### **AC power adapters**

**AC-9V** (requires CP-W126 DC coupler): Use for extended shooting and playback or when copying pictures to a computer.

#### **DC couplers**

**CP-W126:** Connect the AC-9V to the camera.

#### **Remote releases**

**RR-90:** Use to reduce camera shake or keep the shutter open during a time exposure.

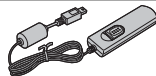

### FUJINON Lenses

**XF-series lenses:** Interchangeable lenses for use exclusively with the FUJIFILM X-mount.



**XC-series lenses:** Interchangeable lenses for use exclusively with the FUJIFILM X-mount.

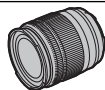

### Grip belts

**GB-001:** GB-001 enhances the camera's hold, allowing users to carry the camera firmly with just one hand.

### Macro extension tubes

**MCEX-11/16:** Attach between the camera and the lens to shoot at high reproduction ratios.

### Protector Filters

**PRF-39/PRF-43/PRF-52/PRF-58/PRF-62/PRF-67/PRF-72/PRF-77:** Use to protect the lens.

### Teleconverters

**XF1.4X TC WR:** Increases the focal length of the compatible lenses by about 1.4x.

**XF2X TC WR:** Increases the focal length of the compatible lenses by about 2x.

### Mount Adapters

**FUJIFILM M MOUNT ADAPTER:** Allows the camera to be used with a wide selection of M-mount lenses.

### Body caps

**BCP-001:** Cover the camera lens mount when no lens is attached.

### instax SHARE printers

**SP-1/SP-2:** Connect via wireless LAN to print pictures on instax film.

## Connecting the Camera to Other Devices

### Remote Shutter Release

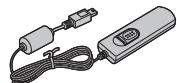

RR-90 remote release\*

### Printing

instax SHARE printer\*

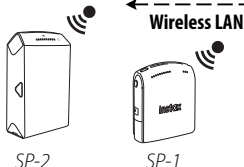

SP-2

SP-1

X-A10



SD/SDHC/SDXC  
memory card†



### Computer Related



Computer†

USB cable (supplied)

### Lens



XF-series lenses\*



XC-series lenses\*

### Macro Extension Tube



MCEX-11/16\*

### M Mount Adapter



FUJIFILM  
M MOUNT  
ADAPTER\*

### Teleconverter

XF1.4X TC WR\*  
XF2X TC WR\*

### Audio/Visual

HDMI cable†



HDTV†

\* Available separately from FUJIFILM.

† Available separately from third-party suppliers. Use an HDMI cable no more than 1.5 m (4.9 ft.) long.

## **Caring for the Camera**

---

To ensure continued enjoyment of the product, observe the following precautions.

### **Storage and Use**

If the camera will not be used for an extended period, remove the battery and memory card. Do not store or use the camera in locations that are:

- exposed to rain, steam, or smoke
- very humid or extremely dusty
- exposed to direct sunlight or very high temperatures, such as in a closed vehicle on a sunny day
- extremely cold
- subject to strong vibration
- exposed to strong magnetic fields, such as near a broadcasting antenna, power line, radar emitter, motor, transformer, or magnet
- in contact with volatile chemicals such as pesticides
- next to rubber or vinyl products

### **■ Water and Sand**

Exposure to water and sand can also damage the camera and its internal circuitry and mechanisms. When using the camera at the beach or seaside, avoid exposing the camera to water or sand. Do not place the camera on a wet surface.

### **■ Condensation**

Sudden increases in temperature, such as occur when entering a heated building on a cold day, can cause condensation inside the camera. If this occurs, turn the camera off and wait an hour before turning it on again. If condensation forms on the memory card, remove the card and wait for the condensation to dissipate.

### **Traveling**

Keep the camera in your carry-on baggage. Checked baggage may suffer violent shocks that could damage the camera.

## Cleaning the Image Sensor

Multiple photographs marred by spots or blotches in identical locations may indicate the presence of dust on the camera image sensor. Clean the sensor using the  **SENSOR CLEANING** option in the setup menu (📖 98); if the problem persists, you can clean the sensor manually as described below. Note that there will be a charge to repair or replace the image sensor if it is damaged during cleaning.

- 1 Use a blower (not a brush) to remove dust from the sensor.

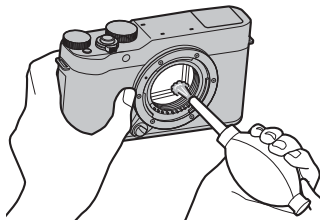

- ① Do not use a brush or blower brush. Failure to observe this precaution could damage the sensor.
- 2 Check whether the dust has been successfully removed.
  - ◆ Repeat Steps 1 and 2 as necessary.
- 3 Replace the body cap or lens.

# Troubleshooting

## Problems and Solutions

### ■ Power and Battery

Problem	Solution
The camera does not turn on.	<ul style="list-style-type: none"><li>• <b>The battery is exhausted:</b> Charge the battery (📖 18) or insert a fully-charged spare battery (📖 14).</li><li>• <b>The battery is inserted incorrectly:</b> Reinsert in the correct orientation (📖 14).</li><li>• <b>The battery-chamber cover is not latched:</b> Latch the battery-chamber cover (📖 15).</li></ul>
The monitor does not turn on.	The monitor may not turn on if the camera is turned off and then on again very quickly. Press the shutter button halfway to activate the monitor.
The battery runs down quickly.	<ul style="list-style-type: none"><li>• <b>The battery is cold:</b> Warm the battery by placing it in a pocket or other warm place and reinsert it in the camera immediately before taking a picture.</li><li>• <b>There is dirt on the battery terminals:</b> Clean the terminals with a soft, dry cloth.</li><li>• <b>📷+ is selected for shooting mode:</b> Select a different shooting mode to reduce the drain on the battery (📖 38).</li><li>• <b>The battery has been charged many times:</b> The battery has reached the end of its charging life. Purchase a new battery.</li></ul>
The camera turns off suddenly.	<b>The battery is exhausted:</b> Charge the battery (📖 18) or insert a fully-charged spare battery (📖 14).
Charging does not start.	Reinsert the battery in the correct orientation and make sure that the charger is plugged in (📖 18).
Charging is slow.	Charge the battery at room temperature (📖 v).
The charging lamp blinks, but the battery does not charge.	<ul style="list-style-type: none"><li>• <b>There is dirt on the battery terminals:</b> Clean the terminals with a soft, dry cloth.</li><li>• <b>The battery has been charged many times:</b> The battery has reached the end of its charging life. Purchase a new battery. If the battery still fails to charge, contact your FUJIFILM dealer.</li></ul>





## ■ Menus and Displays









Problem	Solution
Display is not in English.	Select <b>ENGLISH</b> for  言語/LANG. (📖 95).

## ■ Shooting

Problem	Solution
No picture is taken when the shutter button is pressed.	<ul style="list-style-type: none"> <li>• <b>The memory card is full:</b> Insert a new memory card or delete pictures (📖 14, 32).</li> <li>• <b>The memory card is not formatted:</b> Format the memory card (📖 102).</li> <li>• <b>There is dirt on the memory card contacts:</b> Clean the contacts with a soft, dry cloth.</li> <li>• <b>The memory card is damaged:</b> Insert a new memory card (📖 14).</li> <li>• <b>The battery is exhausted:</b> Charge the battery (📖 18) or insert a fully-charged spare battery (📖 14).</li> <li>• <b>The camera has turned off automatically:</b> Turn the camera on (📖 21).</li> <li>• <b>The indicator lamp was orange when you attempted to record a panorama:</b> Wait until the indicator lamps turns off (📖 42).</li> </ul>
Mottling (“noise”) appears in the monitor when the shutter button is pressed halfway.	Gain is increased to aid composition when the subject is poorly lit and aperture is stopped down, which may result in noticeable mottling when images are previewed in the displays. Images taken with the camera are unaffected.
The camera does not focus.	<b>The subject is not suited to autofocus:</b> Use focus lock (📖 56) or manual focus (📖 53).
Intelligent Face Detection is not available.	<b>Intelligent Face Detection is not available in the current shooting mode:</b> Choose a different shooting mode (📖 38, 137).

Problem	Solution
No face is detected.	<ul style="list-style-type: none"> <li>• <b>The subject's face is obscured by sunglasses, a hat, long hair, or other objects:</b> Remove the obstructions.</li> <li>• <b>The subject's face occupies only a small area of the frame:</b> Change the composition so that the subject's face occupies a larger area of the frame (📖 56).</li> <li>• <b>The subject's head is tilted or horizontal:</b> Ask the subject to hold their head straight.</li> <li>• <b>The camera is tilted:</b> Keep the camera level (📖 28).</li> <li>• <b>The subject's face is poorly lit:</b> Shoot in bright light.</li> </ul>
Wrong subject is selected.	<p>The selected subject is closer to the center of the frame than the main subject. Recompose the picture or turn face detection off and frame the picture using focus lock (📖 56).</p>
The flash does not fire.	<ul style="list-style-type: none"> <li>• <b>The flash can not be used at current settings:</b> See the list of the settings that can be used with the flash (📖 137).</li> <li>• <b>The flash is lowered:</b> Raise the flash (📖 71).</li> <li>• <b>The battery is exhausted:</b> Charge the battery (📖 18) or insert a fully-charged spare battery (📖 14).</li> <li>• <b>The camera is in bracketing or continuous mode:</b> Select single frame mode (📖 60).</li> <li>• <b>OFF is selected for  SOUND &amp; FLASH:</b> Select <b>ON</b> (📖 95).</li> </ul>
Some flash modes are not available.	<p><b>OFF is selected for  SOUND &amp; FLASH:</b> Select <b>ON</b> (📖 95).</p>
The flash does not fully light the subject.	<ul style="list-style-type: none"> <li>• <b>The subject is not in range of the flash:</b> Position the subject in range of the flash (📖 133).</li> <li>• <b>The flash window is obstructed:</b> Hold the camera correctly (📖 28).</li> <li>• <b>Shutter speed is faster than 1/180 s:</b> Choose a slower shutter speed (📖 48, 50, 72).</li> </ul>
Pictures are blurred.	<ul style="list-style-type: none"> <li>• <b>The lens is dirty:</b> Clean the lens (📖 xi).</li> <li>• <b>The lens is blocked:</b> Keep objects away from the lens.</li> <li>• <b>!AF is displayed during shooting and the focus frame is displayed in red:</b> Check focus before shooting (📖 28).</li> </ul>
Pictures are mottled.	<ul style="list-style-type: none"> <li>• <b>Shutter speed is slow and the ambient temperature is high:</b> This is normal and does not indicate a malfunction.</li> <li>• <b>The camera has been used continuously at high temperatures or a temperature warning is displayed:</b> Turn the camera off and wait for it to cool down.</li> </ul>



## ■ Playback











Problem	Solution
Pictures are grainy.	The pictures were taken with a different make or model of camera.
Playback zoom is unavailable.	The pictures were created using  <b>RESIZE</b> or with a different make or model of camera.
No sound in movie playback.	<ul style="list-style-type: none"> <li>• <b>Playback volume is too low:</b> Adjust playback volume ( 96).</li> <li>• <b>The microphone was obstructed:</b> Hold the camera correctly during recording ( 2, 33).</li> <li>• <b>The speaker is obstructed:</b> Hold the camera correctly during playback ( 2, 34).</li> <li>• <b>OFF is selected for  SOUND &amp; FLASH:</b> Select <b>ON</b> ( 95).</li> </ul>
Selected pictures are not deleted.	Some of the pictures selected for deletion are protected. Remove protection using the device with which it was originally applied (  91).
File numbering is unexpectedly reset.	The battery-chamber cover was opened while the camera was on. Turn the camera off before opening the battery-chamber cover (  14, 21).

## ■ Connections/Miscellaneous

For additional information on troubleshooting wireless connections, visit:



<http://digital-cameras.support.fujifilm.com/app?pid=x>

Problem	Solution
Problem connecting or uploading pictures to smartphone.	<ul style="list-style-type: none"> <li>• <b>The smartphone is too far away:</b> Move the devices closer.</li> <li>• <b>Nearby devices are causing radio interference:</b> Move the camera and smartphone away from microwave ovens or cordless phones.</li> </ul>
Can not upload images.	<ul style="list-style-type: none"> <li>• <b>The smartphone is connected to another device:</b> The smartphone and camera can connect to only one device at a time. End the connection and try again.</li> <li>• <b>There are several smartphones in the vicinity:</b> Try connecting again. The presence of multiple smartphones can make connection difficult.</li> <li>• The current image is a movie or was created on another device and can not be uploaded to a smartphone.</li> </ul>
Smartphone will not display pictures.	<p>Select <b>ON</b> for  <b>CONNECTION SETTING &gt; WIRELESS SETTING &gt; RESIZE IMAGE FOR SMARTPHONE</b> . Selecting <b>OFF</b> increases upload times for larger images; in addition, some phones may not display images over a certain size.</p>
No picture or sound on TV.	<ul style="list-style-type: none"> <li>• <b>The camera is not properly connected:</b> Connect the camera properly (🗨️ 114). Note that once the camera is connected, pictures will be displayed on the TV instead of in the camera monitor.</li> <li>• <b>Input on the television is set to "TV":</b> Set input to "HDMI".</li> <li>• <b>The volume on the TV is too low:</b> Use the controls on the television to adjust the volume.</li> </ul>
The computer does not recognize the camera.	<p>Be sure the camera and computer are correctly connected (🗨️ 108).</p>





Problem	Solution
Can not transfer RAW or JPEG files to computer.	Use MyFinePix Studio to transfer pictures (Windows only;  107).
The camera is unresponsive.	<ul style="list-style-type: none"> <li>• <b>Temporary camera malfunction:</b> Remove and reinsert the battery ( 14, 16).</li> <li>• <b>The battery is exhausted:</b> Charge the battery ( 18) or insert a fully-charged spare battery ( 14).</li> <li>• <b>The camera is connected to a wireless LAN:</b> End the connection.</li> </ul>
The camera does not function as expected.	Remove and reinsert the battery (  14, 16). If the problem persists, contact your FUJIFILM dealer.
No sound.	Select <b>ON</b> for  <b>SOUND &amp; FLASH</b> (  95).
Time and date stamps.	<ul style="list-style-type: none"> <li>• <b>Time and date stamps are not correct:</b> Set the camera clock ( 22, 95).</li> <li>• <b>Time and date stamps appear on photographs:</b> Time and date stamps can not be deleted. To prevent stamps appearing on new photographs, select <b>OFF</b> for  <b>SAVE DATA SET-UP &gt; DATE STAMP</b> ( 100).</li> </ul>

## Warning Messages and Displays

The following warnings appear in the display.

Warning	Description
 (red)	Low battery. Charge the battery (📖 18) or insert a fully-charged spare battery (📖 14).
 (blinks red)	Battery exhausted. Charge the battery (📖 18) or insert a fully-charged spare battery (📖 14).
<b>!AF</b> (displayed in red with red focus frame)	The camera can not focus. <ul style="list-style-type: none"><li>• Use focus lock to focus on another subject at the same distance, then recompose the picture (📖 56).</li></ul>
Aperture or shutter speed displayed in red	The subject is too bright or too dark and the picture will be over- or under-exposed. Use the flash for additional lighting when taking photographs of poorly-lit subjects (📖 71).
<b>FOCUS ERROR</b>	
<b>TURN OFF THE CAMERA AND TURN ON AGAIN</b>	Camera malfunction. Turn the camera off and then on again. If the message persists, contact a FUJIFILM dealer.
<b>LENS CONTROL ERROR</b>	
<b>LENS ERROR</b>	Turn the camera off, remove the lens, and clean the mounting surfaces, then replace the lens and turn the camera on. If the problem persists, contact a FUJIFILM dealer.
<b>BUSY</b>	The memory card is incorrectly formatted. Use the camera to format the card (📖 102).
<b>CARD NOT INITIALIZED</b>	<ul style="list-style-type: none"><li>• <b>The memory card is not formatted or the memory card has been formatted in a computer or other device:</b> Format the memory card using the  <b>FORMAT</b> option in the camera setup menu (📖 102).</li><li>• <b>The memory card contacts require cleaning:</b> Clean the contacts with a soft, dry cloth. If the message is repeated, format the card (📖 102). If the message persists, replace the card.</li><li>• <b>Camera malfunction:</b> Contact a FUJIFILM dealer.</li></ul>
<b>PROTECTED CARD</b>	The memory card is locked. Unlock the card (📖 15).

Warning	Description
CARD ERROR	<ul style="list-style-type: none"> <li>• <b>The memory card is not formatted for use in the camera:</b> Format the card (📖 102).</li> <li>• <b>The memory card contacts require cleaning or the memory card is damaged:</b> Clean the contacts with a soft, dry cloth. If the message is repeated, format the card (📖 102). If the message persists, replace the card.</li> <li>• <b>Incompatible memory card:</b> Use a compatible card (📖 17).</li> <li>• <b>Camera malfunction:</b> Contact a FUJIFILM dealer.</li> </ul>
SD MEMORY FULL	The memory card is full and pictures can not be recorded. Delete pictures (📖 32) or insert a memory card with more free space (📖 14).
NO CARD	The shutter can only be released when a memory card is inserted. Insert a memory card.
WRITE ERROR	<ul style="list-style-type: none"> <li>• <b>Memory card error or connection error:</b> Reinsert the card or turn the camera off and then on again. If the message persists, contact a FUJIFILM dealer.</li> <li>• <b>Not enough memory remaining to record additional pictures:</b> Delete pictures (📖 32) or insert a memory card with more free space (📖 14).</li> <li>• <b>The memory card is not formatted:</b> Format the memory card (📖 102).</li> </ul>
READ ERROR	<ul style="list-style-type: none"> <li>• <b>The file is corrupt or was not created with the camera:</b> The file can not be viewed.</li> <li>• <b>The memory card contacts require cleaning:</b> Clean the contacts with a soft, dry cloth. If the message is repeated, format the card (📖 102). If the message persists, replace the card.</li> <li>• <b>Camera malfunction:</b> Contact a FUJIFILM dealer.</li> </ul>
FRAME NO. FULL	The camera has run out of frame numbers (current frame number is 999-9999). Format the memory card and select <b>RENEW</b> for <b>SAVE DATA SET-UP &gt; FRAME NO.</b> . Take a picture to reset frame numbering to 100-0001, then select <b>CONTINUOUS</b> for <b>FRAME NO.</b> (📖 99).











Warning	Description
<b>PROTECTED FRAME</b>	An attempt was made to delete or rotate a protected picture. Remove protection and try again (🗨️ 91).
<b>CAN NOT CROP</b>	The picture is damaged or was not created with the camera.
 <b>CANNOT EXECUTE</b>	Red-eye removal can not be applied to pictures created with other devices.
 <b>CANNOT EXECUTE</b>	Red-eye removal can not be applied to movies.
<b>CAN NOT ROTATE</b>	The selected picture can not be rotated.
 <b>CAN NOT ROTATE</b>	Movies can not be rotated.
<b>DPOF FILE ERROR</b>	The DPOF print order on the current memory card contains more than 999 images. Copy the pictures to a computer and create a new print order.
<b>CAN NOT SET DPOF</b>	The picture can not be printed using DPOF.
 <b>CAN NOT SET DPOF</b>	Movies can not be printed using DPOF.
	Turn the camera off and wait for it to cool. Mottling may increase in pictures taken when this warning is displayed.



# Appendix

## Memory Card Capacity

The following table shows the recording time or number of pictures available at different image sizes. All figures are approximate; file size varies with the scene recorded, producing wide variations in the number of files that can be stored. The number of exposures or length remaining may not diminish at an even rate.

Capacity		8 GB		16 GB	
		 FINE	 NORMAL	 FINE	 NORMAL
Photographs	 3:2	800	1270	1650	2630
	RAW	150		320	
Movies <sup>1</sup>	 1080/30P <sup>2</sup>	26 min.		54 min.	
	 1080/25P <sup>2</sup>				
	 1080/24P <sup>2</sup>				
	 720/60P <sup>3</sup>	51 min.		105 min.	
	 720/50P <sup>3</sup>				
 720/24P <sup>3</sup>					

1 Use a CLASS10 card or better.

2 Individual movies can not exceed 14 minutes in length.

3 Individual movies can not exceed 27 minutes in length.

## Links

For more information on FUJIFILM digital camera, visit the websites listed below.

### **FUJIFILM X-A10 Product Information**

Optional accessories and support information can be found on the following website.



### **Firmware Updates**

Updates to product firmware may result in changes not described in the manual. For more information, visit: [http://www.fujifilm.com/support/digital\\_cameras/software/fw\\_table.html](http://www.fujifilm.com/support/digital_cameras/software/fw_table.html)



#### **Checking the Firmware Version**

① The camera will only display the firmware version if a memory card is inserted.

- 1 Turn the camera off and check that a memory card is inserted.
- 2 Turn the camera on while pressing the **DISP/BACK** button. The current firmware version will be displayed; check the firmware version.
- 3 Turn the camera off.

◆ If a lens is attached to the camera, you can also check the lens firmware version.



## Specifications



<b>System</b>	
<b>Model</b>	FUJIFILM X-A10
<b>Effective pixels</b>	16.28 million
<b>Image sensor</b>	23.6 mm × 15.6 mm (APS-C format), CMOS (complementary metal-oxide semiconductor) image sensor with square pixels and primary color filter
<b>Storage media</b>	FUJIFILM-recommended SD/SDHC/SDXC memory cards
<b>File system</b>	Compliant with <b>D</b> esign Rule for <b>C</b> amera <b>F</b> ile System (DCF), Exif 2.3, and <b>D</b> igital <b>P</b> rint <b>O</b> rder <b>F</b> ormat (DPOF)
<b>File format</b>	<ul style="list-style-type: none"><li>• <b>Still pictures:</b> Exif 2.3 JPEG (compressed); RAW (original RAF format, special-purpose software required); RAW+JPG available</li><li>• <b>Movies:</b> H.264 standard with stereo sound (MOV)</li></ul>
<b>Image size</b>	<ul style="list-style-type: none"><li>• <b>L 3:2:</b> 4,896 × 3,264</li><li>• <b>M 3:2:</b> 3,456 × 2,304</li><li>• <b>S 3:2:</b> 2,496 × 1,664</li><li>• <b>L 16:9:</b> 4,896 × 2,760</li><li>• <b>M 16:9:</b> 3,456 × 1,944</li><li>• <b>S 16:9:</b> 2,496 × 1,408</li><li>• <b>L panorama:</b> 2,160 × 9,600 (vertical) / 9,600 × 1,440 (horizontal)</li><li>• <b>M panorama:</b> 2,160 × 6,400 (vertical) / 6,400 × 1,440 (horizontal)</li><li>• <b>L 1:1:</b> 3,264 × 3,264</li><li>• <b>M 1:1:</b> 2,304 × 2,304</li><li>• <b>S 1:1:</b> 1,664 × 1,664</li></ul>
<b>Lens mount</b>	FUJIFILM X mount
<b>Sensitivity</b>	Standard output sensitivity equivalent to ISO 200–6400 in increments of 1/3 EV; AUTO; extended output sensitivity equivalent to ISO 100, 12800, or 25600
<b>Metering</b>	256-segment <b>through-the-lens</b> (TTL) metering; MULTI, SPOT, AVERAGE
<b>Exposure control</b>	Programmed AE (with program shift); shutter-priority AE; aperture-priority AE; manual exposure
<b>Exposure compensation</b>	–3 EV – +3 EV in increments of 1/3 EV

## System

## Shutter speed

- MECHANICAL SHUTTER
    - **P mode:** 4 sec. to  $\frac{1}{4,000}$  sec.
    - **Bulb:** Max. 60 min.
  - ELECTRONIC SHUTTER
    - **P, S, A, and M modes:** 1 sec. to  $\frac{1}{32,000}$  sec.
    - **Bulb:** Fixed at 1 sec.
  - MECHANICAL + ELECTRONIC
    - **P mode:** 4 sec. to  $\frac{1}{32,000}$  sec.
    - **Bulb:** Max. 60 min.
- **Time:** 30 sec. to  $\frac{1}{4,000}$  sec.  
 - **All other modes:** 30 sec. to  $\frac{1}{4,000}$  sec.  
 - **Time:** 1 sec. to  $\frac{1}{32,000}$  sec.  
 - **Time:** 30 sec. to  $\frac{1}{32,000}$  sec.  
 - **All other modes:** 30 sec. to  $\frac{1}{32,000}$  sec.

## Continuous

Mode		Frame rate (fps)	Frames per burst
		6.0	Up to approximately 20
		3.0	Until card is full

 Use a CLASS10 card or better.

 The frame rate varies with shooting conditions and the number of images recorded.

## Focus

- **Mode:** Single or continuous AF; manual focus with focus ring; AF+MF
- **Focus-area selection:** Manual focus, multi, area with focus area size selection (7 × 7 = 49 areas available), continuous, subject tracking
- **Autofocus system:** Contrast-detect TTL AF with AF-assist illuminator

## White balance

Custom, color temperature selection, auto, direct sunlight, shade, daylight fluorescent, warm white fluorescent, cool white fluorescent, incandescent, underwater

## Self-timer

Off, 2 sec., 10 sec., Smile, Buddy, Group

## System

<b>Flash</b>	<ul style="list-style-type: none"> <li>• <b>Type:</b> Manual pop-up flash unit</li> <li>• <b>Guide number:</b> Approx. 7/22 (ISO 200, m/ft.)</li> </ul>
<b>Mode</b>	Auto, fill flash, off, slow sync, rear-curtain sync, commander (red-eye removal off); auto with red-eye removal, fill flash with red-eye removal, off, slow sync with red-eye removal, rear-curtain sync with red-eye removal, commander (red-eye removal on)

## Hot shoe

–

## LCD monitor

3.0-in/7.6 cm, 1040k-dot color LCD monitor; frame coverage approx. 100%

## Movies

- **HD 1080/30P:** Frame size 1,920 × 1,080 (1080p); 30 fps; stereo sound
- **HD 1080/25P:** Frame size 1,920 × 1,080 (1080p); 25 fps; stereo sound
- **HD 1080/24P:** Frame size 1,920 × 1,080 (1080p); 24 fps; stereo sound
- **HD 720/60P:** Frame size 1,280 × 720 (720p); 60 fps; stereo sound
- **HD 720/50P:** Frame size 1,280 × 720 (720p); 50 fps; stereo sound
- **HD 720/24P:** Frame size 1,280 × 720 (720p); 24 fps; stereo sound

## Input/output terminals

## HDMI output

HDMI Micro connector (Type D)

## Digital input/output

USB 2.0 High-Speed, Micro USB connector (Micro-B)

Power supply/other					
<b>Power supply</b>	NP-W126S rechargeable battery				
<b>Battery life</b> (approximate number of frames that can be taken with a fully-charged battery and XF 35 mm f/1.4 R lens)	<table border="1"> <thead> <tr> <th>Battery type</th> <th>Approximate number of frames</th> </tr> </thead> <tbody> <tr> <td>NP-W126S (type supplied with camera)</td> <td>410</td> </tr> </tbody> </table>	Battery type	Approximate number of frames	NP-W126S (type supplied with camera)	410
	Battery type	Approximate number of frames			
NP-W126S (type supplied with camera)	410				
CIPA standard, measured using battery supplied with camera and SD memory card. <b>Note:</b> Number of shots that can be taken with battery varies with battery charge level and will decline at low temperatures.					
<b>Charging time</b>	Approx. 210 minutes (+20°C/+68°F)				
<b>Camera size</b> (W × H × D)	116.9mm × 67.4 mm × 40.4 mm (32.1 mm excluding projections, measured at thinnest part)/4.6 in. × 2.7 in. × 1.6 in. (1.3 in.)				
<b>Camera weight</b>	Approx. 282 g/9.9 oz., excluding battery, accessories, and memory card				
<b>Shooting weight</b>	Approx. 331 g/11.7 oz., including battery and memory card				
<b>Operating conditions</b>	<ul style="list-style-type: none"> <li>• <b>Temperature:</b> 0°C to +40°C/+32°F to +104°F</li> <li>• <b>Humidity:</b> 10% – 80% (no condensation)</li> </ul>				
Wireless transmitter					
<b>Standards</b>	IEEE 802.11b/g/n (standard wireless protocol)				
<b>Operating frequency</b>	<ul style="list-style-type: none"> <li>• <b>U. S. A., Canada, Taiwan:</b> 2,412 MHz–2,462 MHz (11 channels)</li> <li>• <b>Other countries:</b> 2,412 MHz–2,472 MHz (13 channels)</li> </ul>				
<b>Access protocols</b>	Infrastructure				

**NP-W126S rechargeable battery**

<b>Nominal voltage</b>	7.2V DC
<b>Nominal capacity</b>	1,260 mAh
<b>Operating temperature</b>	0°C to +40°C/+32°F to +104°F
<b>Dimensions (W×H×D)</b>	36.4 mm × 47.1 mm × 15.7 mm/1.4 in. × 1.8 in. × 0.6 in.
<b>Weight</b>	Approx. 47 g/1.7 oz.

**AC-5VF AC power adapter**

<b>Rated input</b>	100V–240V AC, 50/60Hz
<b>Input capacity</b>	11.6 VA (100 V), 15.5 VA (240 V)
<b>Rated output</b>	5.0V DC, 1000 mA
<b>Operating temperature</b>	0°C to +40°C/+32°F to +104°F
<b>Weight</b>	Approx. 32 g/1.1 oz. (AC power adapter only)

Weight and dimensions vary with the country or region of sale. Labels, menus, and other displays may differ from those on the actual camera.

■ **Notices**

- Specifications subject to change without notice; for the latest information, visit [http://www.fujifilm.com/products/digital\\_cameras/index.html](http://www.fujifilm.com/products/digital_cameras/index.html). FUJIFILM shall not be held liable for damages resulting from errors in this manual.
- Although the LCD monitor is manufactured using advanced high-precision technology, small bright points and anomalous colors may appear, particularly in the vicinity of text. This is normal for this type of LCD display and does not indicate a malfunction; images recorded with the camera are unaffected.
- Digital cameras may malfunction when exposed to strong radio interference (e.g., electric fields, static electricity, or line noise).
- Due to the type of lens used, some distortion may occur at the periphery of images. This is normal.



## Restrictions on Camera Settings

The options available in each shooting mode are listed below.

		SB+	Adv.	P	S	A	M	(G)	▲	▲	▲	▲	SP										▶	▶						
		Adv.	▶	▶	▶	▶	▶	▶	▶	▶	▶	▶	▶	▶	▶	▶	▶	▶	▶	▶	▶	▶	▶	▶	▶	▶	▶			
EXPOSURE		✓	✓	✓	✓	✓	✓	✓	✓	✓	✓	✓	✓	✓	✓	✓	✓	✓	✓	✓	✓	✓	✓	✓	✓	✓	✓	✓		
CONTINUOUS SHOOTING		✓			✓	✓	✓	✓	✓	✓	✓	✓	✓	✓	✓	✓	✓	✓	✓	✓	✓	✓	✓	✓	✓	✓	✓	✓		
BRACKETING					✓	✓	✓	✓																						
AF/MF SETTING	FOCUS AREA		✓		✓	✓	✓	✓																				✓		
	FOCUS MODE	MF			✓	✓	✓	✓			✓	✓	✓			✓	✓	✓	✓	✓	✓	✓	✓	✓	✓	✓	✓	✓		
		+			✓	✓	✓	✓	✓																					
		+		✓ <sup>3</sup>	✓	✓	✓	✓	✓	✓	✓	✓	✓	✓	✓	✓	✓	✓	✓	✓	✓	✓	✓	✓	✓	✓	✓	✓	✓	
		+	✓ <sup>3</sup>		✓	✓	✓	✓	✓	✓	✓	✓	✓	✓	✓	✓	✓	✓	✓	✓	✓	✓	✓	✓	✓	✓	✓	✓		
	AF+MF				✓	✓	✓	✓	✓		✓	✓	✓			✓	✓	✓	✓	✓	✓	✓	✓	✓	✓	✓	✓	✓		
	FACE/EYE DETECTION SETTING	FACE DETECTION	✓	✓		✓	✓	✓	✓	✓				✓	✓	✓			✓	✓	✓	✓						✓		
		EYE DETECTION AF	✓	✓		✓	✓	✓	✓	✓				✓	✓	✓			✓	✓	✓	✓								
	AF ILLUMINATOR		✓	✓		✓	✓	✓	✓	✓				✓	✓	✓			✓	✓						✓	✓	✓		
	ISO	AUTO1-3			✓	✓	✓	✓	✓																				✓	
H (25600)				✓	✓	✓	✓																					✓		
H (12800)				✓	✓	✓	✓																					✓		
6400-1000				✓	✓	✓	✓																					✓		
800			✓	✓	✓	✓	✓																					✓		
640-400			✓	✓	✓	✓	✓																					✓		
320-200			✓	✓	✓	✓	✓																					✓		
L (100)					✓	✓	✓	✓																				✓		



		SR+	Adv.	P	S	A	M	(●)	▲	⚡	☾	SP											📷	📶								
		Adv.	☐	☐	☐	☐	☐	☐	☐	☐	☐	☐	☐	☐	☐	☐	☐	☐	☐	☐	☐	☐	☐	☐	☐	☐						
MF ASSIST	STANDARD	✓	✓ <sup>3</sup>	✓	✓	✓	✓	✓	✓	✓	✓	✓	✓	✓	✓	✓	✓	✓	✓	✓	✓	✓	✓	✓	✓	✓	✓					
	FOCUS PEAK HIGHLIGHT			✓	✓	✓	✓	✓	✓	✓	✓	✓	✓	✓	✓	✓	✓	✓	✓	✓	✓	✓	✓	✓	✓	✓	✓	✓				
PHOTOMETRY	☐	✓ <sup>3</sup>	✓ <sup>3</sup>	✓	✓	✓	✓	✓	✓ <sup>3</sup>	✓ <sup>3</sup>	✓ <sup>3</sup>	✓ <sup>3</sup>	✓ <sup>3</sup>	✓ <sup>3</sup>	✓ <sup>3</sup>	✓ <sup>3</sup>	✓ <sup>3</sup>	✓ <sup>3</sup>	✓ <sup>3</sup>	✓ <sup>3</sup>	✓ <sup>3</sup>	✓ <sup>3</sup>	✓ <sup>3</sup>	✓ <sup>3</sup>	✓ <sup>3</sup>	✓	✓					
	☐			✓	✓	✓	✓	✓																			✓	✓				
	☐			✓	✓	✓	✓	✓																				✓	✓			
FLASH SET-UP	FLASH MODE	RED EYE REMOVAL OFF	AUTO	✓	✓	✓	✓	✓	✓	✓	✓	✓	✓	✓	✓	✓	✓	✓	✓	✓	✓	✓	✓	✓	✓	✓	✓	✓	✓			
		⚡	✓	✓	✓	✓	✓	✓	✓	✓	✓	✓	✓	✓	✓	✓	✓	✓	✓	✓	✓	✓	✓	✓	✓	✓	✓	✓	✓	✓		
		S↓		✓	✓	✓	✓	✓	✓	✓	✓	✓	✓	✓	✓	✓	✓	✓	✓	✓	✓	✓	✓	✓	✓	✓	✓	✓	✓	✓	✓	
		Ⓢ		✓	✓	✓	✓	✓	✓	✓	✓	✓	✓	✓	✓	✓	✓	✓	✓	✓	✓	✓	✓	✓	✓	✓	✓	✓	✓	✓	✓	
		Ⓢ	✓	✓	✓	✓	✓	✓	✓	✓	✓	✓	✓	✓	✓	✓	✓	✓	✓	✓	✓	✓	✓	✓	✓	✓	✓	✓	✓	✓	✓	
		Ⓢ	✓	✓	✓	✓	✓	✓	✓	✓	✓	✓	✓	✓	✓	✓	✓	✓	✓	✓	✓	✓	✓	✓	✓	✓	✓	✓	✓	✓	✓	✓
		Ⓢ	✓	✓	✓	✓	✓	✓	✓	✓	✓	✓	✓	✓	✓	✓	✓	✓	✓	✓	✓	✓	✓	✓	✓	✓	✓	✓	✓	✓	✓	✓
		Ⓢ	✓	✓	✓	✓	✓	✓	✓	✓	✓	✓	✓	✓	✓	✓	✓	✓	✓	✓	✓	✓	✓	✓	✓	✓	✓	✓	✓	✓	✓	✓
	RED EYE REMOVAL ON	AUTO	✓			✓			✓		✓			✓				✓	✓	✓								✓	✓			
		⚡	✓			✓	✓	✓	✓	✓			✓					✓	✓	✓								✓	✓			
		Ⓢ	✓			✓	✓	✓	✓	✓			✓					✓	✓	✓								✓	✓			
		Ⓢ	✓			✓	✓	✓	✓	✓			✓					✓	✓	✓								✓	✓			
RED EYE REMOVAL	OFF	✓	✓ <sup>1</sup>	✓	✓ <sup>1</sup>	✓	✓	✓	✓	✓ <sup>1</sup>	✓ <sup>1</sup>	✓	✓	✓	✓	✓	✓	✓	✓	✓	✓	✓	✓	✓	✓	✓	✓	✓	✓			
	ON	✓			✓	✓	✓	✓	✓			✓	✓	✓	✓	✓	✓	✓	✓	✓	✓	✓	✓	✓	✓	✓	✓	✓	✓	✓		
	(●) <sub>1</sub>	✓ <sup>3</sup>			✓	✓	✓	✓	✓	✓	✓	✓	✓	✓	✓	✓	✓	✓	✓	✓	✓	✓	✓	✓	✓	✓	✓	✓	✓	✓		
	OFF	✓	✓	✓	✓	✓	✓	✓	✓	✓	✓	✓	✓	✓	✓	✓	✓	✓	✓	✓	✓	✓	✓	✓	✓	✓	✓	✓	✓	✓	✓	
IS MODE <sup>5</sup>	(●) <sub>1</sub>	✓ <sup>3</sup>			✓	✓	✓	✓	✓	✓	✓	✓	✓	✓	✓	✓	✓	✓	✓	✓	✓	✓	✓	✓	✓	✓	✓	✓	✓			
	(●) <sub>1</sub>		✓		✓	✓	✓	✓	✓	✓	✓	✓	✓	✓	✓	✓	✓	✓	✓	✓	✓	✓	✓	✓	✓	✓	✓	✓	✓	✓	✓	
	(●) <sub>2</sub>				✓	✓	✓	✓	✓	✓	✓	✓	✓	✓	✓	✓	✓	✓	✓	✓	✓	✓	✓	✓	✓	✓	✓	✓	✓	✓	✓	
	OFF		✓	✓	✓	✓	✓	✓	✓	✓	✓	✓	✓	✓	✓	✓	✓	✓	✓	✓	✓	✓	✓	✓	✓	✓	✓	✓	✓	✓	✓	✓

		5G+	Adv.				P	S	A	M	📶	📶	📶	🌙	SP													📶	📶
			📷	📷	📷	📷									📷	📷	📷	📷	📷	📷	📷	📷	📷	📷	📷	📷	📷		
SCREEN SET-UP	PREVIEW EXP. IN MANUAL MODE		✓	✓	✓				✓																			✓	
	PREVIEW PIC. EFFECT	✓	✓	✓	✓	✓	✓	✓	✓	✓	✓	✓	✓	✓	✓	✓	✓	✓	✓	✓	✓	✓	✓	✓	✓	✓	✓	✓	
	FOCUS CHECK		✓		✓	✓	✓	✓	✓	✓																			

- 1 Fixed at **OFF**.
- 2 Fixed at **ON**.
- 3 Changes automatically depending on mode.
- 4 Not available in 📷 **HIGH KEY**, 📷 **LOW KEY**, or 📷 **DYNAMIC TONE** mode.
- 5 Compatible lenses only.
- 6 Wireless remote photography.







# FUJIFILM

---

**FUJIFILM Corporation**

7-3, AKASAKA 9-CHOME, MINATO-KU, TOKYO 107-0052, JAPAN

[http://www.fujifilm.com/products/digital\\_cameras/index.html](http://www.fujifilm.com/products/digital_cameras/index.html)